

LMH6611/LMH6612

Single Supply 345 MHz Rail-to-Rail Output Amplifiers

General Description

The LMH6611 (single, with shutdown) and LMH6612 (dual) are 345 MHz rail-to-rail output amplifiers consuming just 3.2 mA of quiescent current per channel and designed to deliver high performance in power conscious single supply systems. The LMH6611 and LMH6612 have precision trimmed input offset voltages with low noise and low distortion performance as required for high accuracy video, test and measurement, and communication applications. The LMH6611 and LMH6612 are members of the PowerWise family and have an exceptional power-to-performance ratio.

With a trimmed input offset voltage of 0.022 mV and a high open loop gain of 103 dB the LMH6611 and LMH6612 meet the requirements of DC sensitive high speed applications such as low pass filtering in baseband I and Q radio channels. These specifications combined with a 0.01% settling time of 100 ns, a low noise of 10 nV/ $\sqrt{\text{Hz}}$ and better than 102 dBc SFDR at 100 kHz make these amplifiers particularly suited to driving 10, 12 and 14-bit high speed ADCs. The 45 MHz 0.1 dB bandwidth ($A_V = 2$) driving 2 V_{PP} into 150 Ω allows the amplifiers to be used as output drivers in 1080i and 720p HDTV applications.

The input common mode range extends from 200 mV below the negative supply rail up to 1.2V from the positive rail. On a single 5V supply with a ground terminated 150 Ω load the output swings to within 49 mV of the ground, while a mid-rail terminated 1 k Ω load will swing to 77 mV of either rail.

The amplifiers will operate on a 2.7V to 11V single supply or $\pm 1.35\text{V}$ to $\pm 5.5\text{V}$ split supply. The LMH6611 single is available in 6-Pin TSOT23 and has an independent active low disable pin which reduces the supply current to 120 μA . The LMH6612 is available in 8-Pin SOIC. Both the LMH6611 and LMH6612 are available in -40°C to $+125^\circ\text{C}$ extended industrial temperature grade.

Features

$V_S = 5\text{V}$, $R_L = 1\text{ k}\Omega$, $T_A = 25^\circ\text{C}$ and $A_V = +1$, unless otherwise specified.

■ Operating voltage range	2.7V to 11V
■ Supply current per channel	3.2 mA
■ Small signal bandwidth	345 MHz
■ Open loop gain	103 dB
■ Input offset voltage (limit at 25°C)	$\pm 0.750\text{ mV}$
■ Slew rate	460 V/ μs
■ 0.1 dB bandwidth	45 MHz
■ Settling time to 0.1%	67 ns
■ Settling time to 0.01%	100 ns
■ SFDR ($f = 100\text{ kHz}$, $A_V = 2$, $V_{OUT} = 2 V_{PP}$)	102 dBc
■ Low voltage noise	10 nV/ $\sqrt{\text{Hz}}$
■ Output current	$\pm 100\text{ mA}$
■ CMVR	-0.2V to 3.8V
■ Rail-to-Rail output	
■ -40°C to $+125^\circ\text{C}$ temperature range	

Applications

- ADC driver
- DAC buffer
- Active filters
- High speed sensor amplifier
- Current sense amplifier
- 1080i and 720p analog video amplifier
- STB, TV video amplifier
- Video switching and muxing

Typical Application

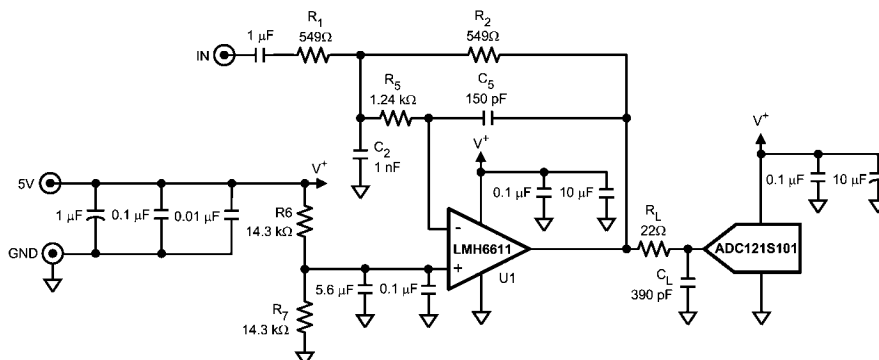

30033629

Absolute Maximum Ratings (Note 1)

If Military/Aerospace specified devices are required, please contact the National Semiconductor Sales Office/Distributors for availability and specifications.

ESD Tolerance (Note 2)		
Human Body Model		
For input pins only	2000V	
For all other pins	2000V	
Machine Model	200V	
Charge Device Model	1000V	

Supply Voltage ($V_S = V^+ - V^-$)	12V
Junction Temperature (Note 3)	150°C max

Operating Ratings (Note 1)

Supply Voltage ($V_S = V^+ - V^-$)	2.7V to 11V
Ambient Temperature Range (Note 3)	-40°C to +125°C
Package Thermal Resistance (θ_{JA})	
6-Pin TSOT23	231°C/W
8-Pin SOIC	160°C/W

+3V Electrical Characteristics

Unless otherwise specified, all limits are guaranteed for $T_J = +25^\circ\text{C}$, $V^+ = 3\text{V}$, $V^- = 0\text{V}$, $V_S = V^+ - V^-$, $\overline{\text{DISABLE}} = 3\text{V}$, $V_{CM} = V_O = V^+/2$, $A_V = +1$, $R_F = 0\Omega$, when $A_V \neq +1$ then $R_F = 560\Omega$, $R_L = 1\text{k}\Omega$. **Boldface** limits apply at temperature extremes. (Note 4)

Symbol	Parameter	Condition	Min (Note 8)	Typ (Note 7)	Max (Note 8)	Units
Frequency Domain Response						
SSBW	-3 dB Bandwidth Small Signal	$A_V = 1$, $R_L = 1\text{k}\Omega$, $V_{OUT} = 0.2 V_{PP}$		305		MHz
		$A_V = 2, -1$, $R_L = 1\text{k}\Omega$, $V_{OUT} = 0.2 V_{PP}$		115		
GBW	Gain Bandwidth (LMH6611)	$A_V = 10$, $R_F = 2\text{k}\Omega$, $R_G = 221\Omega$, $R_L = 1\text{k}\Omega$, $V_{OUT} = 0.2 V_{PP}$	115	135		MHz
	Gain Bandwidth (LMH6612)	$A_V = 10$, $R_F = 2\text{k}\Omega$, $R_G = 221\Omega$, $R_L = 1\text{k}\Omega$, $V_{OUT} = 0.2 V_{PP}$		130		
LSBW	-3 dB Bandwidth Large Signal	$A_V = 1$, $R_L = 1\text{k}\Omega$, $V_{OUT} = 1.5 V_{PP}$		90		MHz
		$A_V = -1$, $R_L = 150\Omega$, $V_{OUT} = 2 V_{PP}$		85		
Peak	Peaking	$A_V = 1$		1.0		dB
0.1 dBBW	0.1 dB Bandwidth	$A_V = 1$, $V_{OUT} = 0.5 V_{PP}$, $R_L = 1\text{k}\Omega$		33		MHz
		$A_V = 2$, $V_{OUT} = 0.5 V_{PP}$, $R_L = 1\text{k}\Omega$ $R_F = R_G = 560\Omega$		65		
		$A_V = 2$, $V_{OUT} = 1.5 V_{PP}$, $R_L = 150\Omega$, $R_F = R_G = 510\Omega$		47		
DG	Differential Gain	$A_V = 2$, 4.43 MHz, $0.6\text{V} < V_{OUT} < 2\text{V}$, $R_L = 150\Omega$ to $V^+/2$		0.03		%
DP	Differential Phase	$A_V = 2$, 4.43 MHz, $0.6\text{V} < V_{OUT} < 2\text{V}$, $R_L = 150\Omega$ to $V^+/2$		0.06		deg
Time Domain Response						
t_r/t_f	Rise & Fall Time	1.5V Step, $A_V = 1$		2.8		ns
SR	Slew Rate	2V Step, $A_V = 1$		330		V/ μs
$t_{s,0.1}$	0.1% Settling Time	2V Step, $A_V = -1$		74		ns
$t_{s,0.01}$	0.01% Settling Time	2V Step, $A_V = -1$		116		
Noise and Distortion Performance						
SFDR	Spurious Free Dynamic Range	$f_C = 100\text{kHz}$, $A_V = -1$, $V_{OUT} = 2 V_{PP}$		109		dBc
		$f_C = 1\text{MHz}$, $A_V = -1$, $V_{OUT} = 2 V_{PP}$		97		
		$f_C = 5\text{MHz}$, $A_V = -1$, $V_{OUT} = 2 V_{PP}$		80		
e_n	Input Voltage Noise	$f = 100\text{kHz}$		10		$\text{nV}/\sqrt{\text{Hz}}$
i_n	Input Current Noise	$f = 100\text{kHz}$		2		$\text{pA}/\sqrt{\text{Hz}}$
CT	Crosstalk (LMH6612)	$f = 5\text{MHz}$, $V_{IN} = 2 V_{PP}$		71		dB

Symbol	Parameter	Condition	Min (Note 8)	Typ (Note 7)	Max (Note 8)	Units		
Input, DC Performance								
V_{OS}	Input Offset Voltage (LMH6611)	$V_{CM} = 0.5V$		0.022	± 0.600 ± 1.0	mV		
	Input Offset Voltage (LMH6612)	$V_{CM} = 0.5V$		-0.015	± 0.750 ± 1.3			
TCV_{OS}	Input Offset Voltage Average Drift	(Note 5)		0.1		$\mu V/^{\circ}C$		
I_B	Input Bias Current	$V_{CM} = 0.5V$		-5.9	-10.1 -11.1	μA		
I_O	Input Offset Current			0.01	± 0.5 ± 0.7	μA		
C_{IN}	Input Capacitance			2.5		pF		
R_{IN}	Input Resistance			6		$M\Omega$		
CMVR	Input Voltage Range	DC, CMRR ≥ 76 dB	-0.2		1.8	V		
CMRR	Common Mode Rejection Ratio	V_{CM} Stepped from -0.1V to 1.7V	79	98		dB		
A_{OL}	Open Loop Gain	$R_L = 1\text{ k}\Omega$, $V_{OUT} = 2.7V$ to $0.3V$	89	101		dB		
		$R_L = 150\Omega$, $V_{OUT} = 2.5V$ to $0.5V$	78	85				
Output DC Characteristics								
V_O	Output Swing High (LMH6611) (Voltage from V+ Supply Rail)	$R_L = 1\text{ k}\Omega$ to $V+/2$		59	72 76	mV		
		$R_L = 150\Omega$ to $V+/2$		133	169 182			
	Output Swing Low (LMH6611) (Voltage from V- Supply Rail)	$R_L = 1\text{ k}\Omega$ to $V+/2$		59	74 80			
		$R_L = 150\Omega$ to $V+/2$		133	171 188			
		$R_L = 150\Omega$ to $V-$		42	52 56			
	Output Swing High (LMH6612) (Voltage from V+ Supply Rail)	$R_L = 1\text{ k}\Omega$ to $V+/2$		58	68 73			
		$R_L = 150\Omega$ to $V+/2$		131	157 172			
	Output Swing Low (LMH6612) (Voltage from V- Supply Rail)	$R_L = 1\text{ k}\Omega$ to $V+/2$		61	71 79			
		$R_L = 150\Omega$ to $V+/2$		139	168 187			
		$R_L = 150\Omega$ to $V-$		43	51 56			
	I_{OUT}	Linear Output Current	$V_{OUT} = V+/2$ (Note 6)		± 70			mA
	R_O	Output Resistance	$f = 1\text{ MHz}$		0.07			Ω
Enable Pin Operation								
	Enable High Voltage Threshold	Enabled (Note 9)	2.0			V		
	Enable Pin High Current	$V_{DISABLE} = 3V$		0.001		μA		
	Enable Low Voltage Threshold	Disabled (Note 9)			1.0	V		
	Enable Pin Low Current	$V_{DISABLE} = 0V$		0.8		μA		
t_{on}	Turn-On Time			18		ns		
t_{off}	Turn-Off Time			50		ns		

Symbol	Parameter	Condition	Min (Note 8)	Typ (Note 7)	Max (Note 8)	Units
Power Supply Performance						
PSRR	Power Supply Rejection Ratio	DC, $V_{CM} = 0.5V$, $V_S = 2.7V$ to $11V$	81	96		dB
I_S	Supply Current (LMH6611)	$R_L = \infty$		3.0	3.4 3.8	mA
	Supply Current (LMH6612) (per channel)	$R_L = \infty$		2.95	3.45 3.9	
I_{SD}	Disable Shutdown Current (LMH6611)	$\overline{DISABLE} = 0V$		101	132	μA
+5V Electrical Characteristics						
Unless otherwise specified, all limits are guaranteed for $T_J = +25^\circ C$, $V^+ = 5V$, $V^- = 0V$, $V_S = V^+ - V^-$, $\overline{DISABLE} = 5V$, $V_{CM} = V_O = V^+/2$, $A_V = +1$, $R_F = 0\Omega$, when $A_V \neq +1$ then $R_F = 560\Omega$, $R_L = 1\text{ k}\Omega$. Boldface limits apply at temperature extremes.						
Symbol	Parameter	Condition	Min (Note 8)	Typ (Note 7)	Max (Note 8)	Units
Frequency Domain Response						
SSBW	-3 dB Bandwidth Small Signal	$A_V = 1$, $R_L = 1\text{ k}\Omega$, $V_{OUT} = 0.2 V_{PP}$		345		MHz
		$A_V = 2, -1$, $R_L = 1\text{ k}\Omega$, $V_{OUT} = 0.2 V_{PP}$		112		
GBW	Gain Bandwidth (LMH6611)	$A_V = 10$, $R_F = 2\text{ k}\Omega$, $R_G = 221\Omega$, $R_L = 1\text{ k}\Omega$, $V_{OUT} = 0.2 V_{PP}$	115	135		MHz
	Gain Bandwidth (LMH6612)	$A_V = 10$, $R_F = 2\text{ k}\Omega$, $R_G = 221\Omega$, $R_L = 1\text{ k}\Omega$, $V_{OUT} = 0.2 V_{PP}$		130		
LSBW	-3 dB Bandwidth Large Signal	$A_V = 1$, $R_L = 1\text{ k}\Omega$, $V_{OUT} = 2 V_{PP}$		77		MHz
		$A_V = 2$, $R_L = 150\Omega$, $V_{OUT} = 2 V_{PP}$		85		
Peak	Peaking	$A_V = 1$		0.3		dB
0.1 dBBW	0.1 dB Bandwidth	$A_V = 1$, $V_{OUT} = 0.5 V_{PP}$, $R_L = 1\text{ k}\Omega$		45		MHz
		$A_V = 2$, $V_{OUT} = 0.5 V_{PP}$, $R_L = 1\text{ k}\Omega$ $R_F = R_G = 680\Omega$		68		
		$A_V = 2$, $V_{OUT} = 2 V_{PP}$, $R_L = 150\Omega$, $R_F = R_G = 665\Omega$		45		
DG	Differential Gain	$A_V = 2$, 4.43 MHz, $0.6V < V_{OUT} < 2V$, $R_L = 150\Omega$ to $V^+/2$		0.05		%
DP	Differential Phase	$A_V = 2$, 4.43 MHz, $0.6V < V_{OUT} < 2V$, $R_L = 150\Omega$ to $V^+/2$		0.06		deg
Time Domain Response						
t_r/t_f	Rise & Fall Time	2V Step, $A_V = 1$		3.6		ns
SR	Slew Rate	2V Step, $A_V = 1$		460		V/ μs
$t_{s,0.1}$	0.1% Settling Time	2V Step, $A_V = -1$		67		ns
$t_{s,0.01}$	0.01% Settling Time	2V Step, $A_V = -1$		100		
Distortion and Noise Performance						
SFDR	Spurious Free Dynamic Range	$f_C = 100\text{ kHz}$, $A_V = 2$, $V_{OUT} = 2 V_{PP}$		102		dBc
		$f_C = 1\text{ MHz}$, $A_V = 2$, $V_{OUT} = 2 V_{PP}$		96		
		$f_C = 5\text{ MHz}$, $A_V = 2$, $V_O = 2 V_{PP}$		82		
e_n	Input Voltage Noise	$f = 100\text{ kHz}$		10		nV/\sqrt{Hz}
i_n	Input Current Noise	$f = 100\text{ kHz}$		2		pA/\sqrt{Hz}
CT	Crosstalk (LMH6612)	$f = 5\text{ MHz}$, $V_{IN} = 2 V_{PP}$		71		dB

Symbol	Parameter	Condition	Min (Note 8)	Typ (Note 7)	Max (Note 8)	Units		
Input, DC Performance								
V_{OS}	Input Offset Voltage (LMH6611)	$V_{CM} = 0.5V$		0.013	± 0.600 ± 1.0	mV		
	Input Offset Voltage (LMH6612)	$V_{CM} = 0.5V$		0.022	± 0.750 ± 1.3			
TCV_{OS}	Input Offset Voltage Average Drift	(Note 5)		0.1		$\mu V/^{\circ}C$		
I_B	Input Bias Current	$V_{CM} = 0.5V$		-6.3	-10.1 -11.1	μA		
I_O	Input Offset Current			0.01	± 0.5 ± 0.7	μA		
C_{IN}	Input Capacitance			2.5		pF		
R_{IN}	Input Resistance			6		$M\Omega$		
CMVR	Input Voltage Range	DC, CMRR ≥ 78 dB	-0.2		3.8	V		
CMRR	Common Mode Rejection Ratio	V_{CM} Stepped from -0.1V to 3.7V	81	98		dB		
A_{OL}	Open Loop Gain	$R_L = 1\text{ k}\Omega$, $V_{OUT} = 4.6V$ to $0.4V$	92	103		dB		
		$R_L = 150\Omega$, $V_{OUT} = 4.4V$ to $0.6V$	80	86				
Output DC Characteristics								
V_O	Output Swing High (LMH6611) (Voltage from V^+ Supply Rail)	$R_L = 1\text{ k}\Omega$ to $V+/2$		76	90 93	mV		
		$R_L = 150\Omega$ to $V+/2$		195	239 256			
	Output Swing Low (LMH6611) (Voltage from V^- Supply Rail)	$R_L = 1\text{ k}\Omega$ to $V+/2$		74	92 98			
		$R_L = 150\Omega$ to $V+/2$		193	243 265			
		$R_L = 150\Omega$ to V^-		48	60 64			
	Output Swing High (LMH6612) (Voltage from V^+ Supply Rail)	$R_L = 1\text{ k}\Omega$ to $V+/2$		75	86 91			
		$R_L = 150\Omega$ to $V+/2$		195	223 241			
	Output Swing Low (LMH6612) (Voltage from V^- Supply Rail)	$R_L = 1\text{ k}\Omega$ to $V+/2$		77	88 98			
		$R_L = 150\Omega$ to $V+/2$		202	234 261			
		$R_L = 150\Omega$ to V^-		49	58 64			
	I_{OUT}	Linear Output Current	$V_{OUT} = V+/2$ (Note 6)		± 100			mA
	R_O	Output Resistance	$f = 1\text{ MHz}$		0.07			Ω
Enable Pin Operation								
	Enable High Voltage Threshold	Enabled (Note 9)	3.0			V		
	Enable Pin High Current	$V_{DISABLE} = 5V$		1.2		μA		
	Enable Low Voltage Threshold	Disabled (Note 9)			2.0	V		
	Enable Pin Low Current	$V_{DISABLE} = 0V$		2.8		μA		
t_{on}	Turn-On Time			20		ns		
t_{off}	Turn-Off Time			60		ns		

Symbol	Parameter	Condition	Min (Note 8)	Typ (Note 7)	Max (Note 8)	Units
Power Supply Performance						
PSRR	Power Supply Rejection Ratio	DC, $V_{CM} = 0.5V$, $V_S = 2.7V$ to $11V$	81	96		dB
I_S	Supply Current (LMH6611)	$R_L = \infty$		3.2	3.6 4.0	mA
	Supply Current (LMH6612) (per channel)	$R_L = \infty$		3.2	3.7 4.25	
I_{SD}	Disable Shutdown Current (LMH6611)	$\overline{DISABLE} = 0V$		120	162	μA

$\pm 5V$ Electrical Characteristics

Unless otherwise specified, all limits are guaranteed for $T_J = +25^\circ C$, $V^+ = 5V$, $V^- = -5V$, $V_S = V^+ - V^-$, $\overline{DISABLE} = 5V$, $V_{CM} = V_O = 0V$, $A_V = +1$, $R_F = 0\Omega$, when $A_V \neq +1$ then $R_F = 560\Omega$, $R_L = 1\text{ k}\Omega$. **Boldface** limits apply at temperature extremes.

Symbol	Parameter	Condition	Min (Note 8)	Typ (Note 7)	Max (Note 8)	Units
Frequency Domain Response						
SSBW	-3 dB Bandwidth Small Signal	$A_V = 1$, $R_L = 1\text{ k}\Omega$, $V_{OUT} = 0.2 V_{PP}$		365		MHz
		$A_V = 2, -1$, $R_L = 1\text{ k}\Omega$, $V_{OUT} = 0.2 V_{PP}$		110		
GBW	Gain Bandwidth (LMH6611)	$A_V = 10$, $R_F = 2\text{ k}\Omega$, $R_G = 221\Omega$, $R_L = 1\text{ k}\Omega$, $V_{OUT} = 0.2 V_{PP}$	115	135		MHz
	Gain Bandwidth (LMH6612)	$A_V = 10$, $R_F = 2\text{ k}\Omega$, $R_G = 221\Omega$, $R_L = 1\text{ k}\Omega$, $V_{OUT} = 0.2 V_{PP}$		130		
LSBW	-3 dB Bandwidth Large Signal	$A_V = 1$, $R_L = 1\text{ k}\Omega$, $V_{OUT} = 2 V_{PP}$		85		MHz
		$A_V = 2$, $R_L = 150\Omega$, $V_{OUT} = 2 V_{PP}$		87		
Peak	Peaking	$A_V = 1$		0.01		dB
0.1 dBBW	0.1 dB Bandwidth	$A_V = 1$, $V_{OUT} = 0.5 V_{PP}$, $R_L = 1\text{ k}\Omega$		92		MHz
		$A_V = 2$, $V_{OUT} = 0.5 V_{PP}$, $R_L = 1\text{ k}\Omega$ $R_F = R_G = 750\Omega$		65		
		$A_V = 2$, $V_{OUT} = 2 V_{PP}$, $R_L = 150\Omega$, $R_F = R_G = 680\Omega$		45		
DG	Differential Gain	$A_V = 2$, 4.43 MHz, $0.6V < V_{OUT} < 2V$, $R_L = 150\Omega$ to $V^+/2$		0.05		%
DP	Differential Phase	$A_V = 2$, 4.43 MHz, $0.6V < V_{OUT} < 2V$, $R_L = 150\Omega$ to $V^+/2$		0.05		deg

Time Domain Response

t_r/t_f	Rise & Fall Time	2V Step, $A_V = 1$		3.5		ns
SR	Slew Rate	2V Step, $A_V = 1$		460		V/ μs
$t_{s,0.1}$	0.1% Settling Time	2V Step, $A_V = -1$		60		ns
$t_{s,0.01}$	0.01% Settling Time	2V Step, $A_V = -1$		100		

Noise and Distortion Performance

SFDR	Spurious Free Dynamic Range	$f_C = 100\text{ kHz}$, $A_V = 2$, $V_{OUT} = 2 V_{PP}$		102		dBc
		$f_C = 1\text{ MHz}$, $A_V = 2$, $V_{OUT} = 2 V_{PP}$		100		
		$f_C = 5\text{ MHz}$, $A_V = 2$, $V_{OUT} = 2 V_{PP}$		81		
e_n	Input Voltage Noise	$f = 100\text{ kHz}$		10		nV/\sqrt{Hz}
i_n	Input Current Noise	$f = 100\text{ kHz}$		2		pA/\sqrt{Hz}
CT	Crosstalk (LMH6612)	$f = 5\text{ MHz}$, $V_{IN} = 2 V_{PP}$		71		dB

Symbol	Parameter	Condition	Min (Note 8)	Typ (Note 7)	Max (Note 8)	Units
Input DC Performance						
V_{OS}	Input Offset Voltage (LMH6611)	$V_{CM} = -4.5V$		0.074	± 0.600 ± 1.1	mV
	Input Offset Voltage (LMH6612)	$V_{CM} = -4.5V$		0.095	± 0.750 ± 1.4	
TCV_{OS}	Input Offset Voltage Average Drift	(Note 5)		0.4		$\mu V/^{\circ}C$
I_B	Input Bias Current	$V_{CM} = -4.5V$		-6.5	-10.1 -11.1	μA
I_O	Input Offset Current			0.01	± 0.5 ± 0.7	μA
C_{IN}	Input Capacitance			2.5		pF
R_{IN}	Input Resistance			6		$M\Omega$
CMVR	Input Voltage Range	DC, CMRR ≥ 81 dB	-5.2		3.8	V
CMRR	Common Mode Rejection Ratio	V_{CM} Stepped from -5.1V to 3.7V	81	98		dB
A_{OL}	Open Loop Gain	$R_L = 1\text{ k}\Omega$, $V_{OUT} = +4.6V$ to $-4.6V$	96	103		dB
		$R_L = 150\Omega$, $V_{OUT} = +4.3V$ to $-4.3V$	80	87		
Output DC Characteristics						
V_O	Output Swing High (LMH6611) (Voltage from V^+ Supply Rail)	$R_L = 1\text{ k}\Omega$ to GND		107	125 130	mV
		$R_L = 150\Omega$ to GND		339	402 433	
	Output Swing Low (LMH6611) (Voltage from V^- Supply Rail)	$R_L = 1\text{ k}\Omega$ to GND		103	123 132	
		$R_L = 150\Omega$ to GND		332	404 445	
		$R_L = 150\Omega$ to V^-		54	70 74	
	Output Swing High (LMH6612) (Voltage from V^+ Supply Rail)	$R_L = 1\text{ k}\Omega$ to GND		107	118 125	
		$R_L = 150\Omega$ to GND		340	375 407	
	Output Swing Low (LMH6612) (Voltage from V^- Supply Rail)	$R_L = 1\text{ k}\Omega$ to GND		108	120 135	
		$R_L = 150\Omega$ to GND		348	389 434	
$R_L = 150\Omega$ to V^-			56	66 74		
I_{OUT}	Linear Output Current	$V_{OUT} = \text{GND}$ (Note 6)		± 120		mA
R_O	Output Resistance	$f = 1\text{ MHz}$		0.07		Ω
Enable Pin Operation						
	Enable High Voltage Threshold	Enabled (Note 9)	0.5			V
	Enable Pin High Current	$V_{DISABLE} = +5V$		17.0		μA
	Enable Low Voltage Threshold	Disabled (Note 9)			-0.5	V
	Enable Pin Low Current	$V_{DISABLE} = -5V$		18.6		μA
t_{on}	Turn-On Time			19		ns
t_{off}	Turn-Off Time			60		ns

Symbol	Parameter	Condition	Min (Note 8)	Typ (Note 7)	Max (Note 8)	Units
Power Supply Performance						
PSRR	Power Supply Rejection Ratio	DC, $V_{CM} = -4.5V$, $V_S = 2.7V$ to $11V$	81	96		dB
I_S	Supply Current (LMH6611)	$R_L = \infty$		3.3	3.8 4.4	mA
	Supply Current (LMH6612) (per channel)	$R_L = \infty$		3.45	4.05 4.85	
I_{SD}	Disable Shutdown Current (LMH6611)	$DISABLE = -5V$		160	212	μA

Note 1: Absolute Maximum Ratings indicate limits beyond which damage to the device may occur. Operating Ratings indicate conditions for which the device is intended to be functional, but specific performance is not guaranteed. For guaranteed specifications and the test conditions, see the Electrical Characteristics.

Note 2: Human Body Model, applicable std. MIL-STD-883, Method 3015.7. Machine Model, applicable std. JESD22-A115-A (ESD MM std. of JEDEC). Field-Induced Charge-Device Model, applicable std. JESD22-C101-C (ESD FICDM std. of JEDEC).

Note 3: The maximum power dissipation is a function of $T_{J(MAX)}$, θ_{JA} . The maximum allowable power dissipation at any ambient temperature is $P_D = (T_{J(MAX)} - T_A) / \theta_{JA}$. All numbers apply for packages soldered directly onto a PC Board.

Note 4: Boldface limits apply to temperature range of $-40^\circ C$ to $125^\circ C$

Note 5: Voltage average drift is determined by dividing the change in V_{OS} by temperature change.

Note 6: Do not short circuit the output. Continuous source or sink currents larger than the I_{OUT} typical are not recommended as they may damage the part.

Note 7: Typical values represent the most likely parametric norm as determined at the time of characterization. Actual typical values may vary over time and will also depend on the application and configuration. The typical values are not tested and are not guaranteed on shipped production material.

Note 8: Limits are 100% production tested at $25^\circ C$. Limits over the operating temperature range are guaranteed through correlations using the Statistical Quality Control (SQC) method.

Note 9: This parameter is guaranteed by design and/or characterization and is not tested in production.

Connection Diagrams

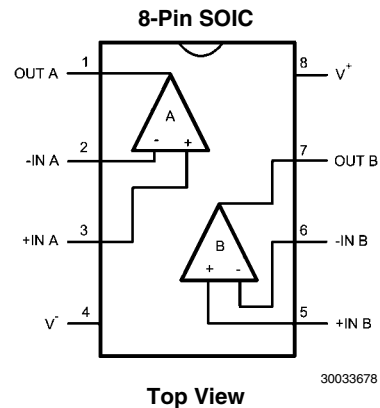
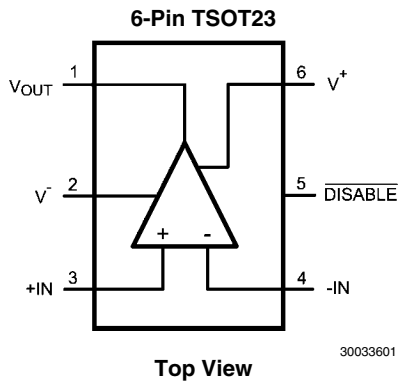

Ordering Information

Package	Part Number	Package Marking	Transport Media	NSC Drawing
6-Pin TSOT23	LMH6611MK	AX4A	1k Units Tape and Reel	MK06A
	LMH6611MKE		250 Units Tape and Reel	
	LMH6611MKX		3k Units Tape and Reel	
8-Pin SOIC	LMH6612MA	LMH6612MA	95 Rail/Units	M08A
	LMH6612MAX		2.5k Units Tape and Reel	

Typical Performance Characteristics At $T_J = 25^\circ\text{C}$, $A_V = +1$ ($R_F = 0\Omega$), otherwise $R_F = 560\Omega$ for $A_V \neq +1$, unless otherwise specified.

Closed Loop Frequency Response for Various Supplies

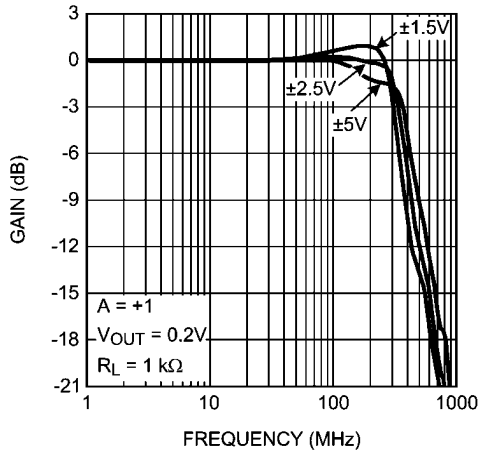

30033625

Closed Loop Frequency Response for Various Supplies

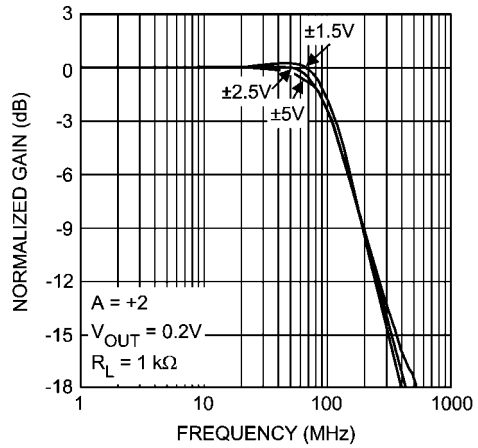

30033624

Closed Loop Frequency Response for Various Supplies

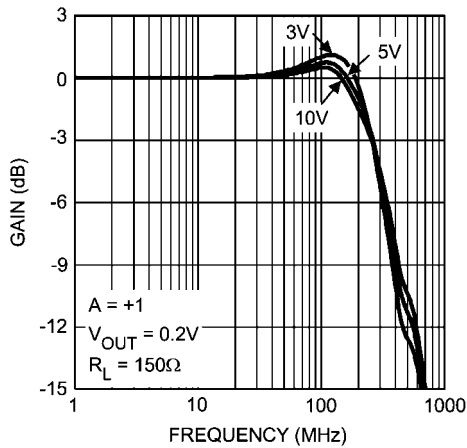

30033604

Closed Loop Frequency Response for Various Supplies (Gain = +2)

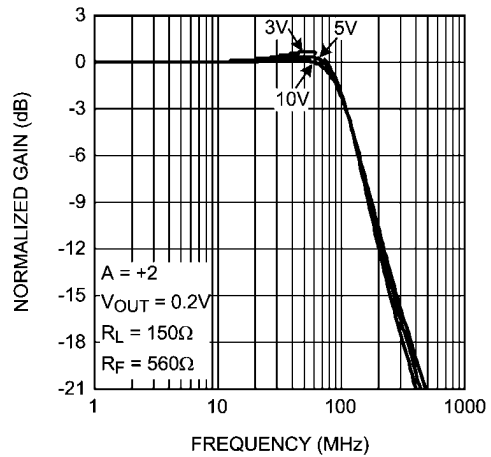

30033605

Closed Loop Gain vs. Frequency for Various Temperatures

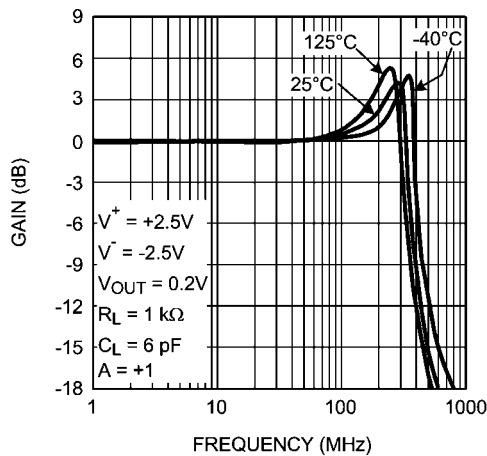

30033654

Closed Loop Gain vs. Frequency for Various Temperatures

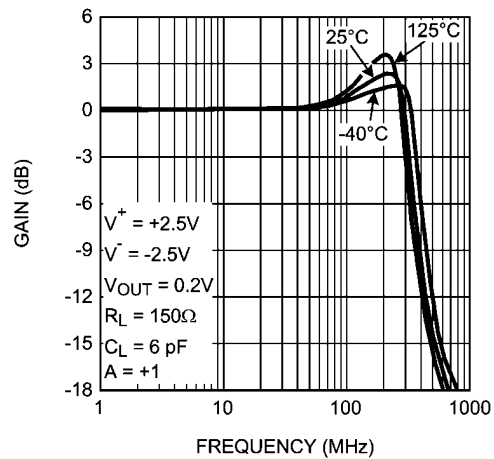

30033655

Closed Loop Gain vs. Frequency for Various Gains

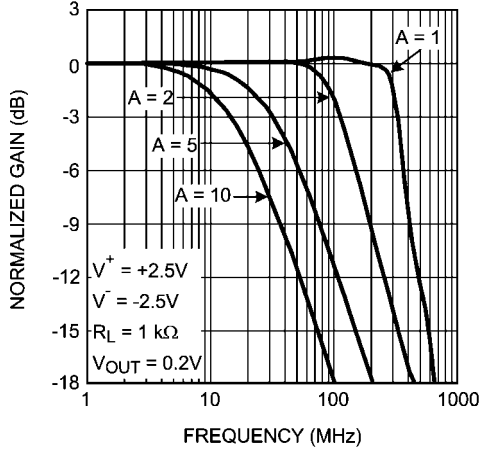

30033623

Large Signal Frequency Response

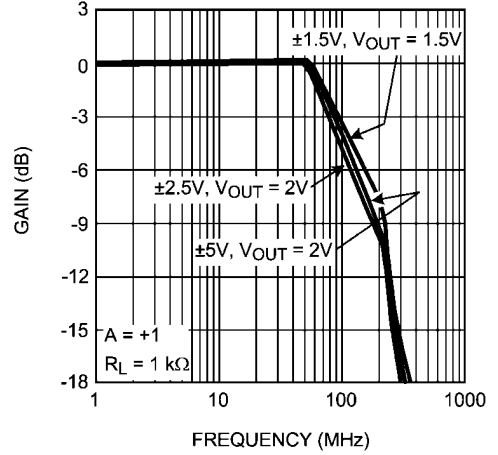

30033630

Large Signal Frequency Response

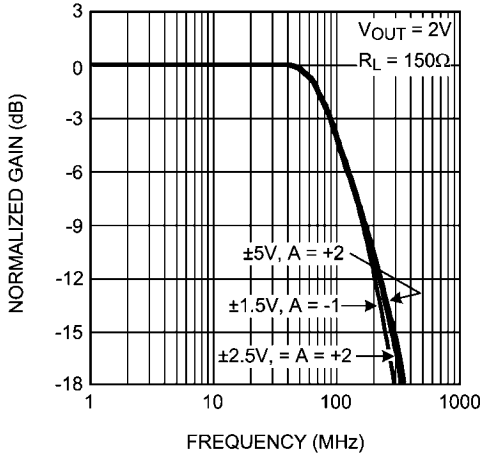

30033631

± 0.1 dB Gain Flatness for Various Supplies

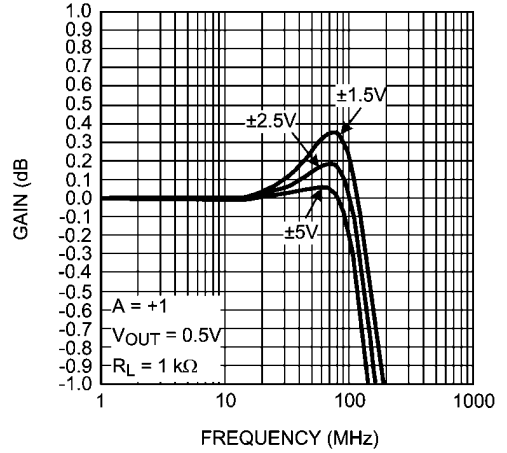

30033626

± 0.1 dB Gain Flatness for Various Supplies

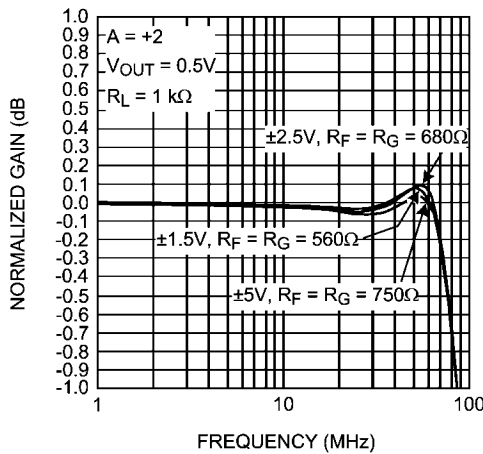

30033627

± 0.1 dB Gain Flatness for Various Supplies

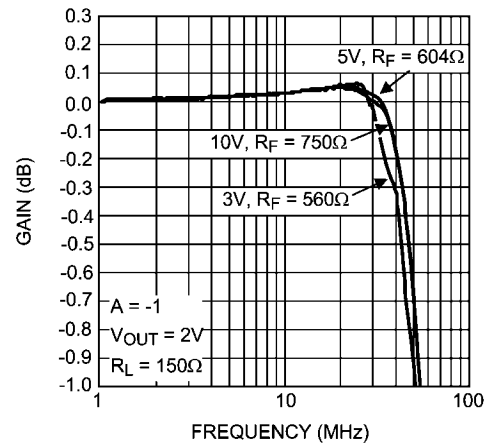

30033606

±0.1 dB Gain Flatness for Various Supplies

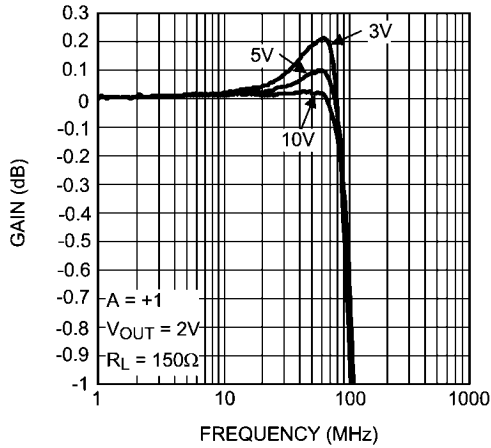

30033607

±0.1 dB Gain Flatness for Various Supplies (Gain = +2)

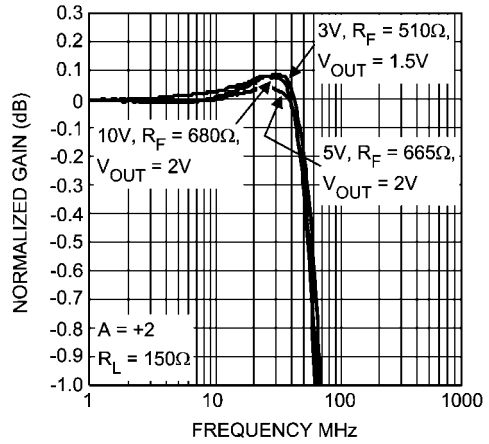

30033675

Small Signal Frequency Response with Various Capacitive Load

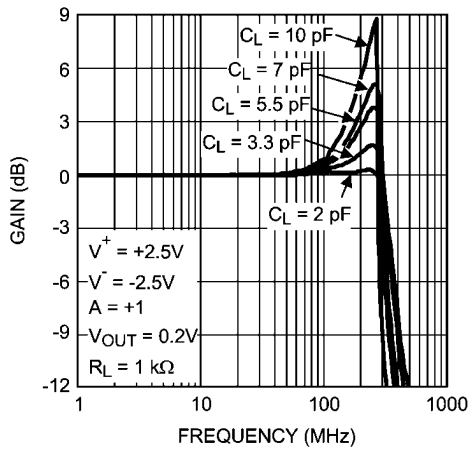

30033608

Small Signal Frequency Response with Capacitive Load and Various RISO

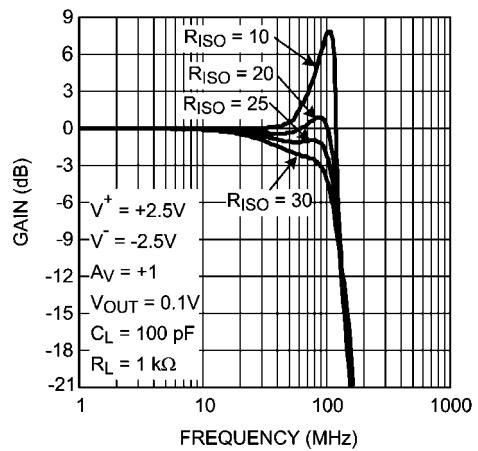

30033609

HD2 and HD3 vs. Frequency and Supply Voltage

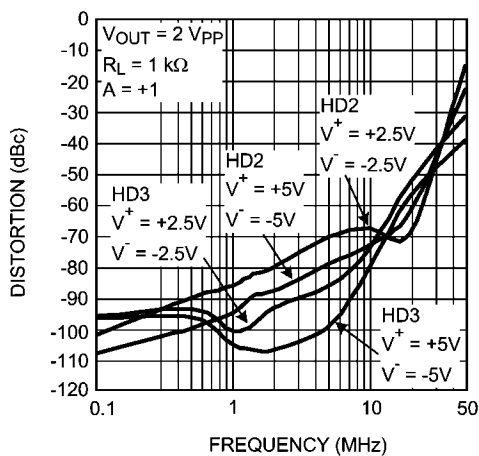

30033653

HD2 and HD3 vs. Frequency and Load

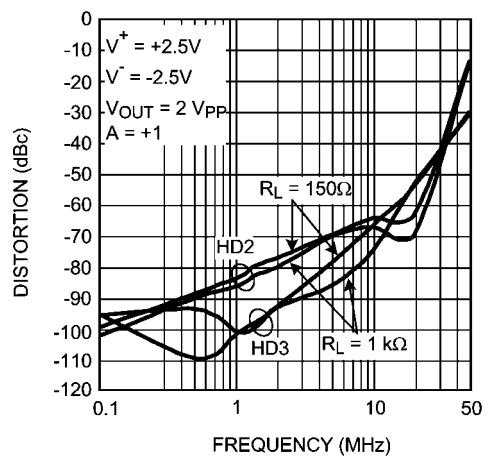

30033650

HD2 and HD3 vs. Common Mode Voltage

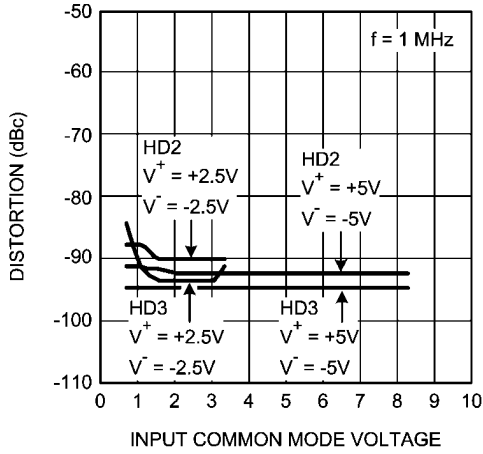

30033677

HD2 and HD3 vs. Common Mode Voltage

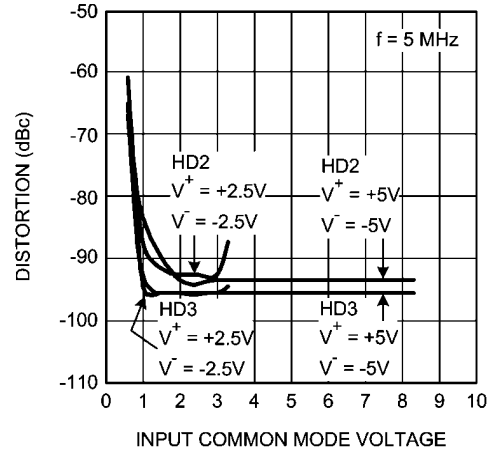

30033681

HD2 vs. Frequency and Gain

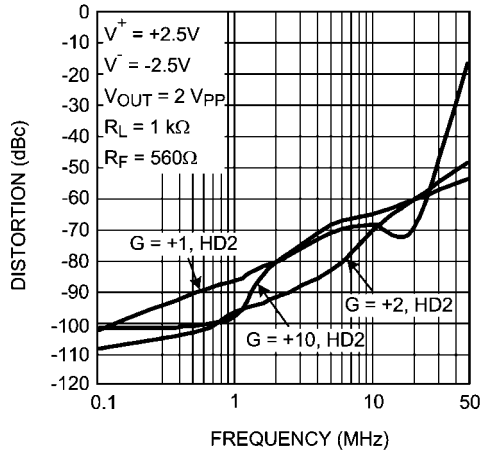

30033651

HD3 vs. Frequency and Gain

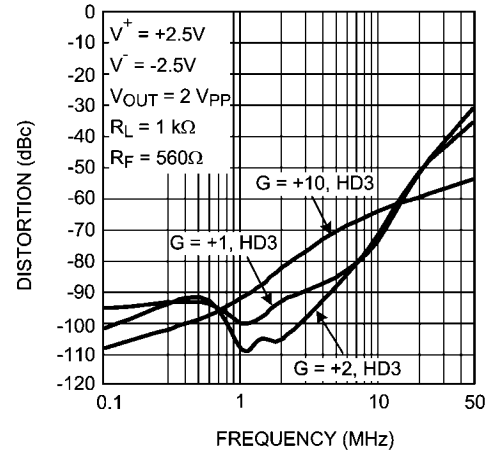

30033652

Open Loop Gain and Phase

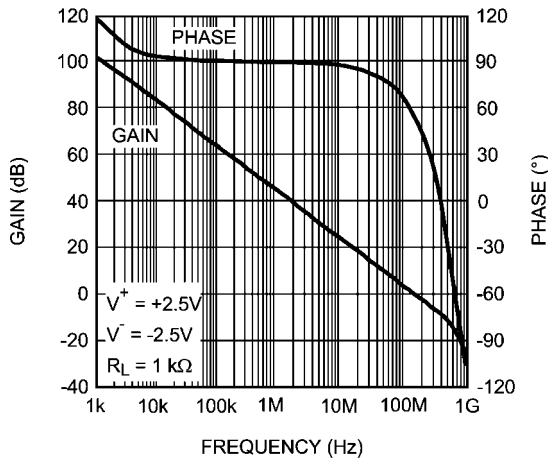

30033676

HD2 vs. Output Swing

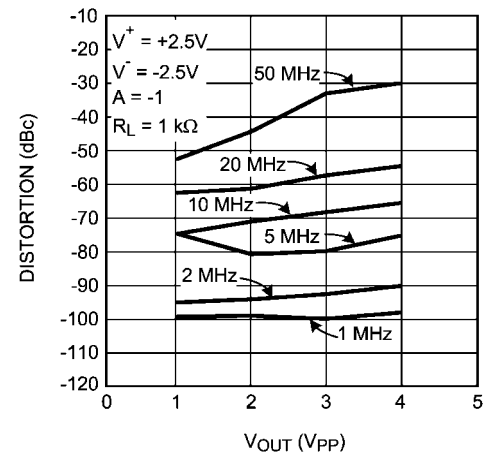

30033682

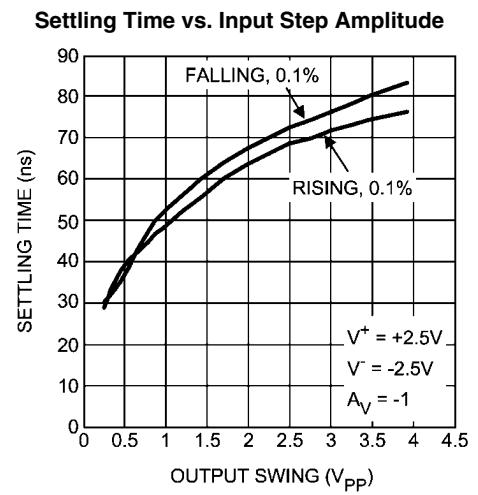
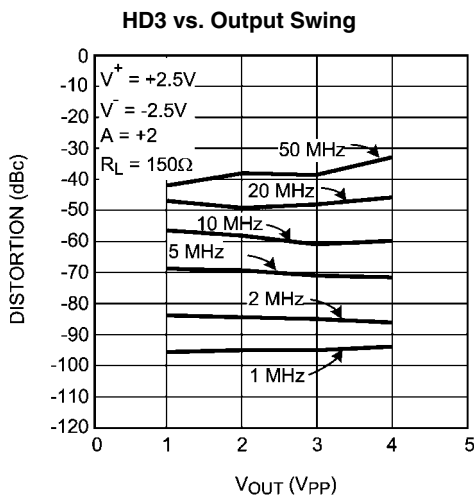
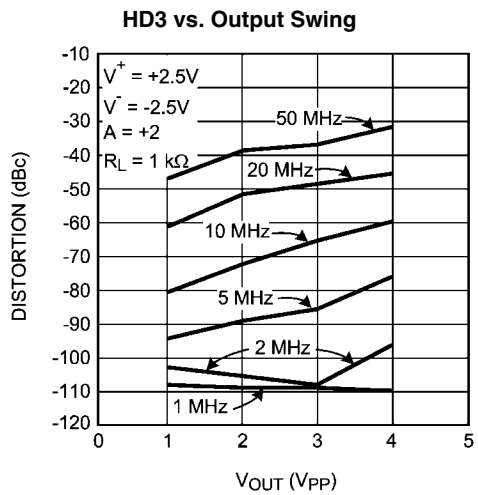
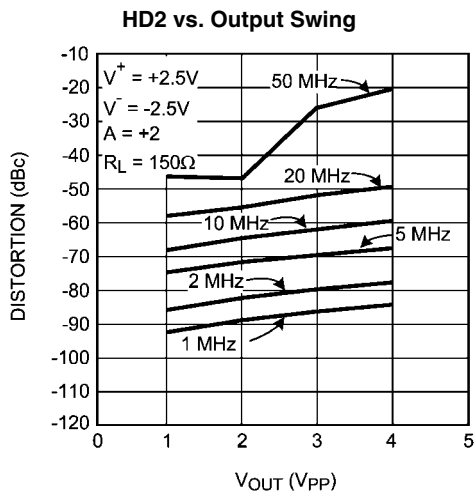
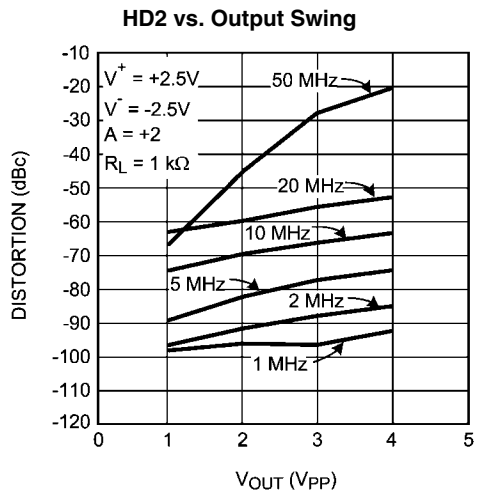
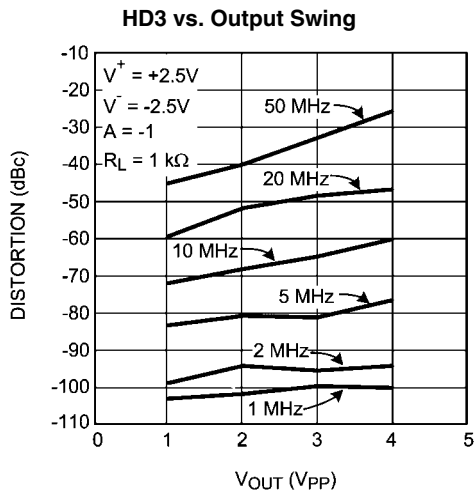

Settling Time vs. Input Step Amplitude

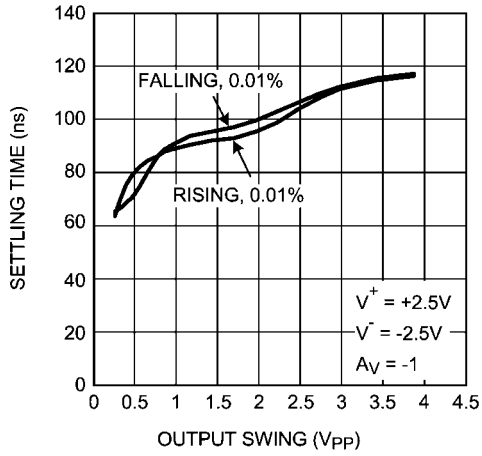

30033687

Input Noise vs. Frequency

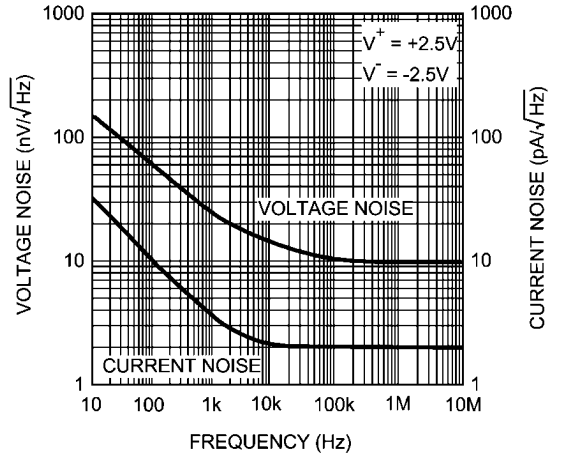

30033674

V_{OS} vs. V_{OUT}

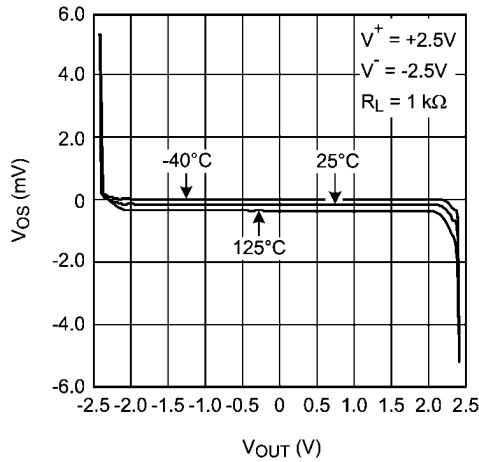

30033661

V_{OS} vs. V_{OUT}

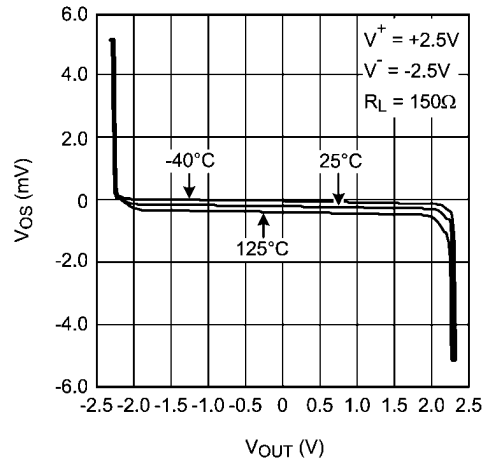

30033668

V_{OS} vs. V_{CM}

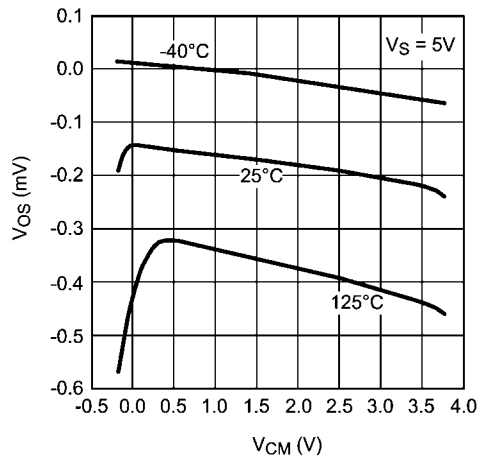

30033660

V_{OS} vs. V_S

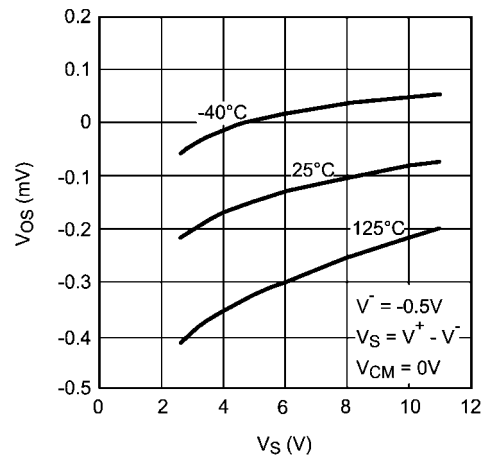

30033658

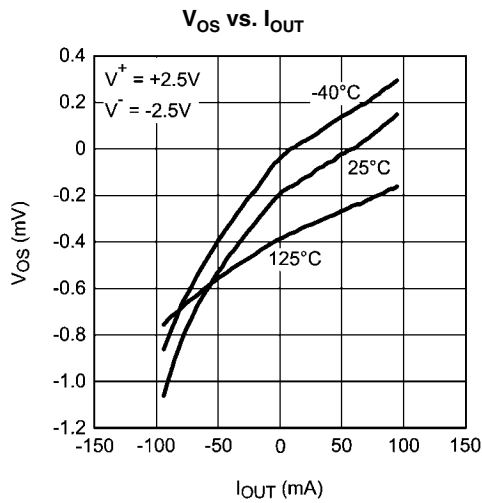

30033669

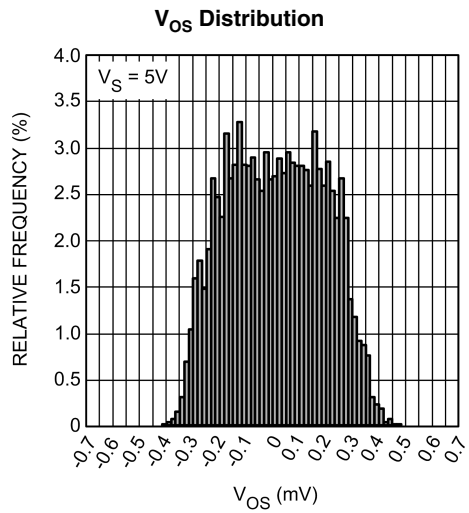

30033672

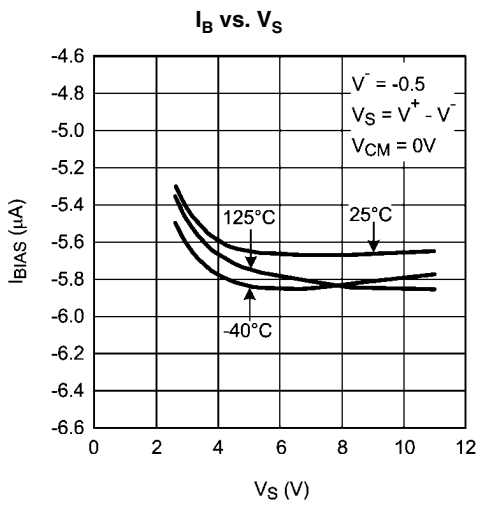

30033659

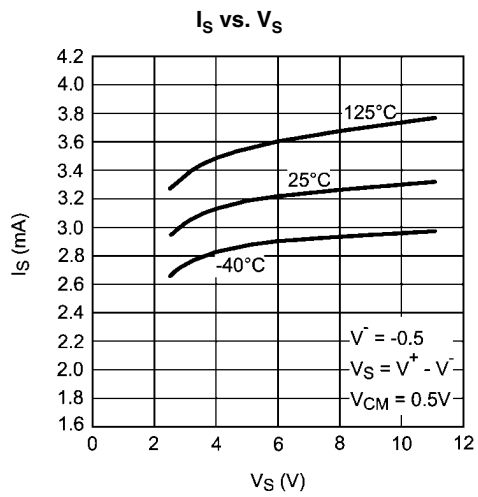

30033657

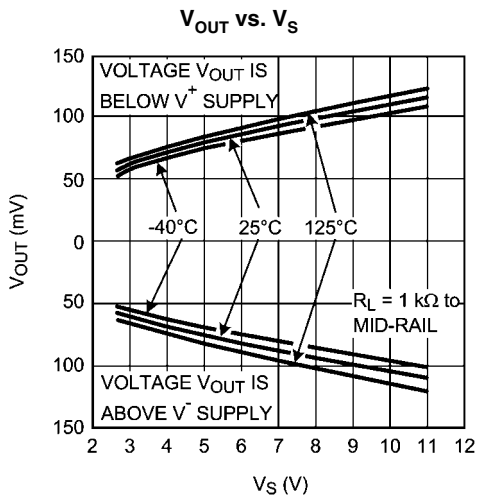

30033690

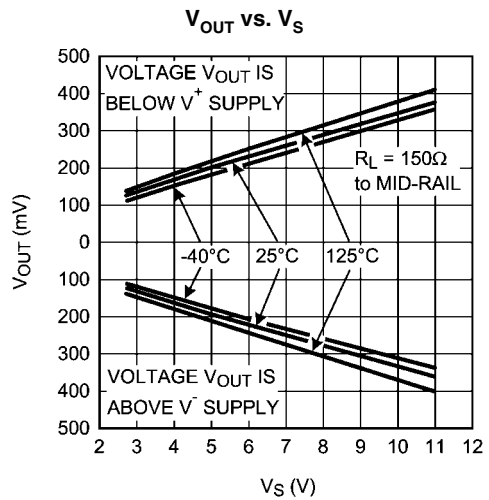

30033691

V_{OUT} vs. V_S

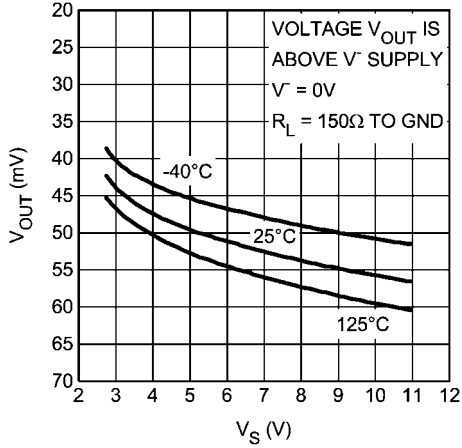

30033671

Closed Loop Output Impedance vs. Frequency $A_V = +1$

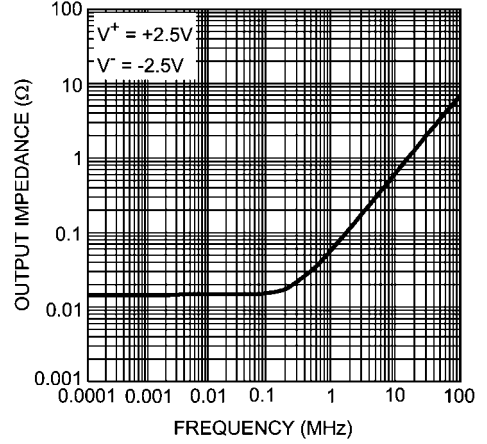

30033696

Circuit for Positive (+) PSRR Measurement

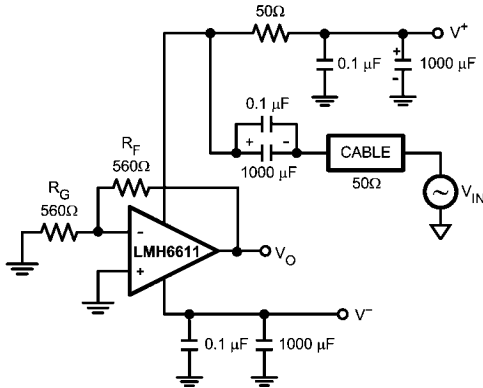

30033688

+PSRR vs. Frequency

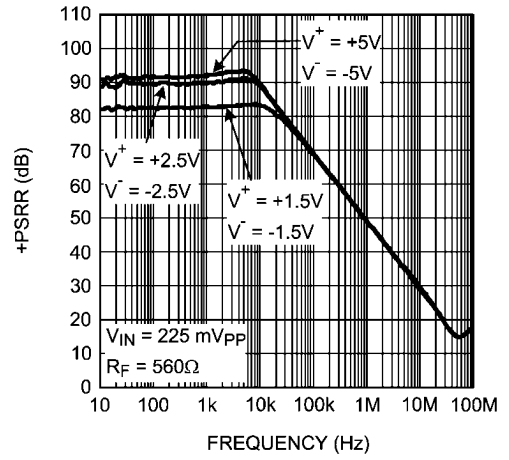

30033633

Circuit for Negative (-) PSRR Measurement

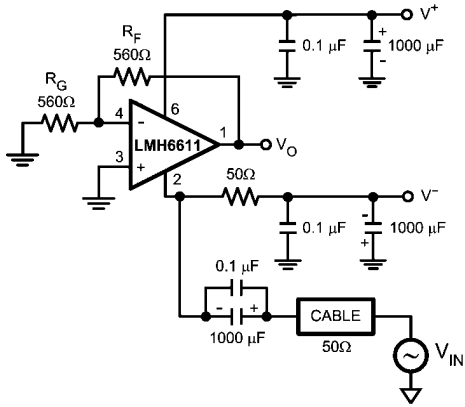

30033689

-PSRR vs. Frequency

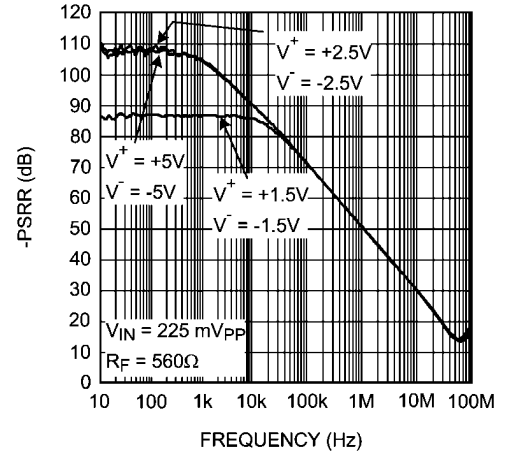

30033634

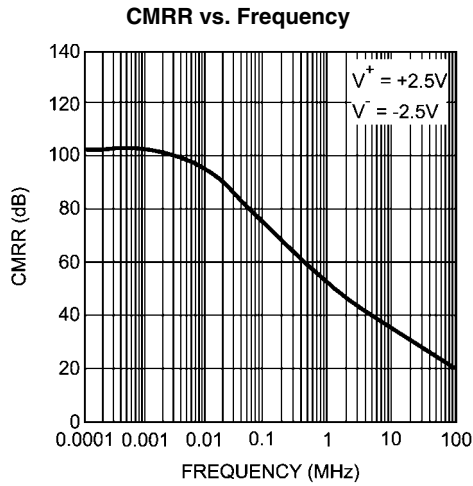

30033697

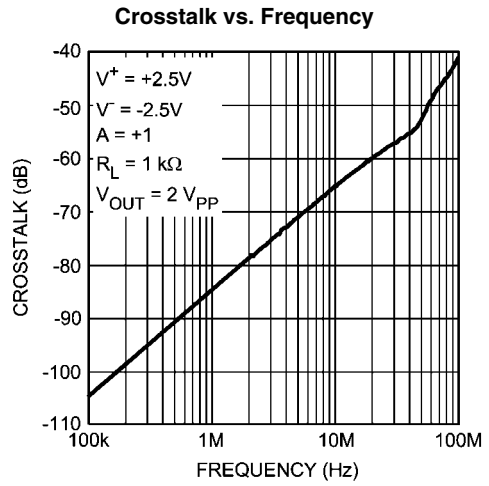

30033632

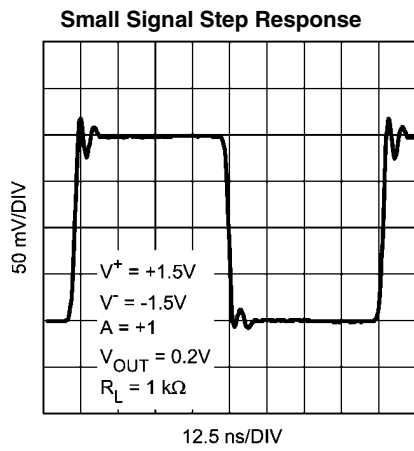

30033610

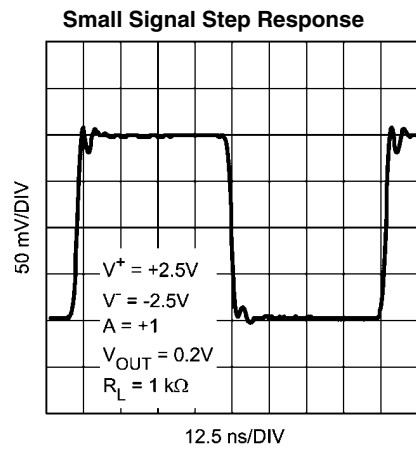

30033611

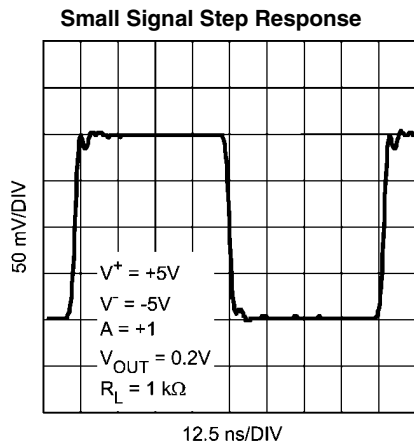

30033612

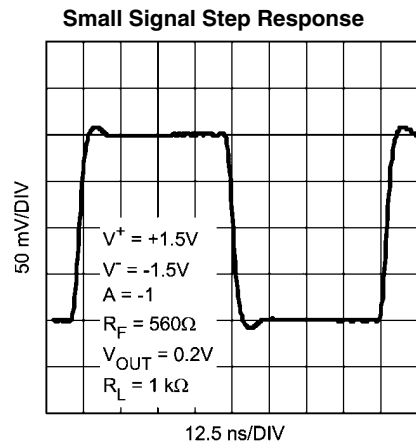

30033614

Small Signal Step Response

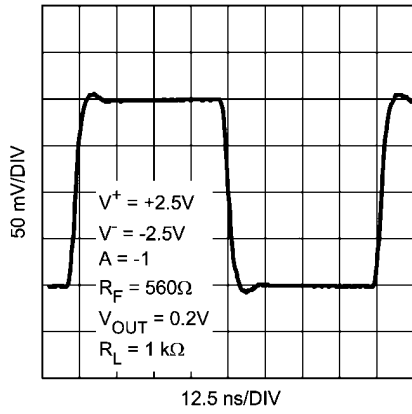

Small Signal Step Response

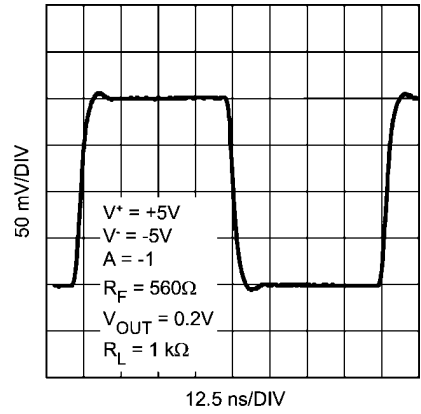

Small Signal Step Response

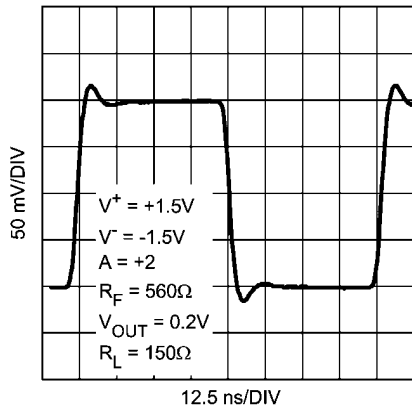

Small Signal Step Response

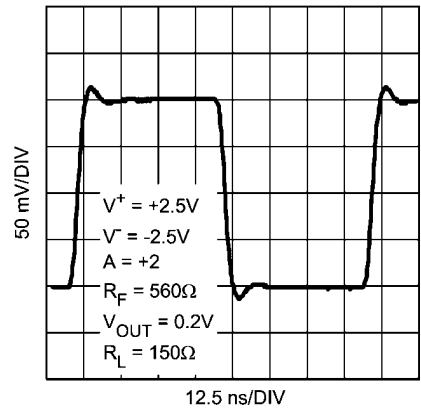

Small Signal Step Response

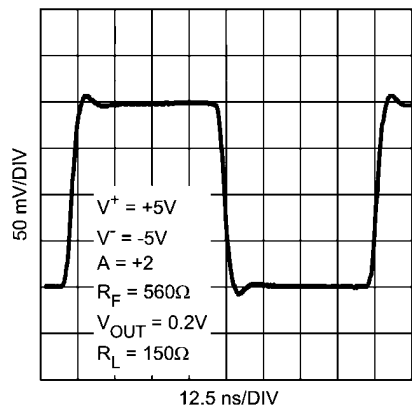

Large Signal Step Response

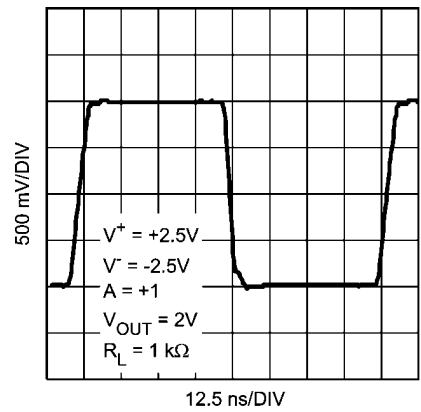

Large Signal Step Response

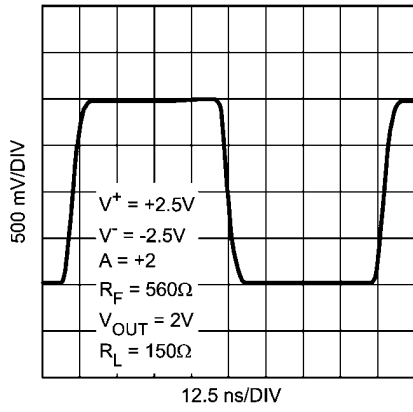

30033620

Overload Recovery Response

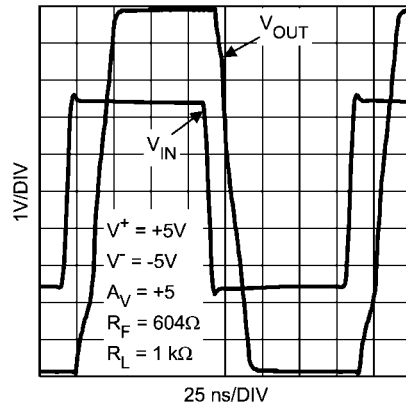

30033621

I_S vs. $V_{DISABLE}$

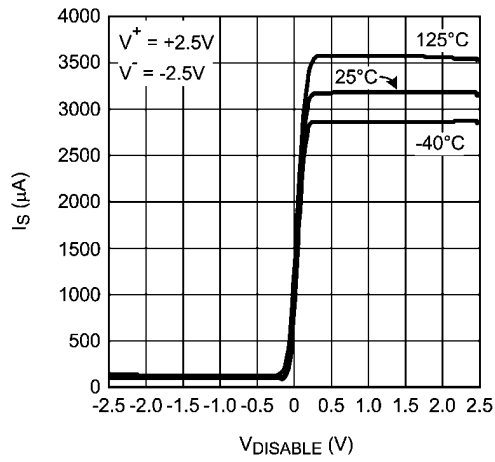

30033656

Application Information

The LMH6611 and LMH6612 are based on National Semiconductor's proprietary VIP10 dielectrically isolated bipolar process. This device family architecture features the following:

- Complimentary bipolar devices with exceptionally high f_t (~8 GHz) even under low supply voltage (2.7V) and low bias current.
- Common emitter push-push output stage. This architecture allows the output to reach within millivolts of either supply rail.
- Consistent performance with little variation from any supply voltage (2.7V - 11V) for the most important specifications (e.g. BW, SR, I_{OUT} .)
- Significant power saving compared to competitive devices on the market with similar performance.

With 3V supplies and a common mode input voltage range that extends beyond either supply rail, the LMH6611 is well suited to many low voltage/low power applications. Even with 3V supplies, the -3 dB BW (at $A_V = +1$) is typically 305 MHz. The LMH6611 and LMH6612 are designed to avoid output phase reversal. With input overdrive, the output is kept near the supply rail (or as close to it as mandated by the closed loop gain setting and the input voltage). *Figure 1* shows the input and output voltage when the input voltage significantly exceeds the supply voltages.

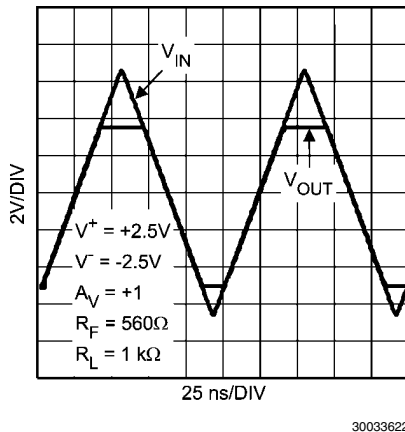

FIGURE 1. Input and Output Shown with CMVR Exceeded

If the input voltage range is exceeded by more than a diode drop beyond either rail, the internal ESD protection diodes will start to conduct. The current flow in these ESD diodes should be externally limited.

SHUTDOWN CAPABILITY AND TURN ON/OFF BEHAVIOR

The LMH6611 can be shutdown by connecting the $\overline{\text{DISABLE}}$ pin to a voltage 0.5V below the supply midpoint which will reduce the supply current to typically 120 μA . The $\overline{\text{DISABLE}}$ pin is "active low" and can be connected through a resistor to V^+ or left floating for normal operation. Shutdown is guaranteed when the $\overline{\text{DISABLE}}$ pin is 0.5V below the supply midpoint at any operating supply voltage and temperature. Typical turn on time is 20 ns and the turn off time is 60 ns.

In the shutdown mode, essentially all internal device biasing is turned off in order to minimize supply current flow and the output goes into high impedance mode. During shutdown, the input stage has an equivalent circuit as shown in *Figure 2*.

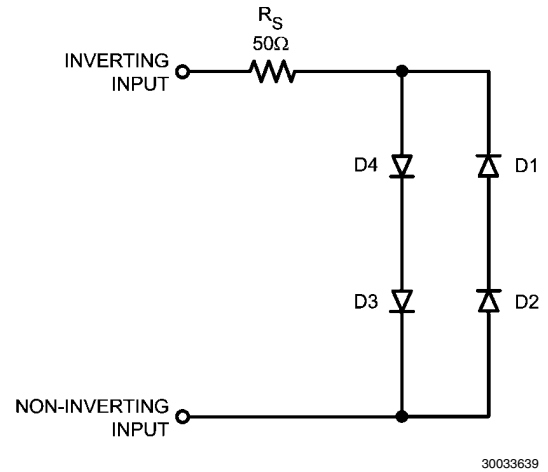

FIGURE 2. Input Equivalent Circuit During Shutdown

When the LMH6611 is shutdown, there may be current flow through the internal diodes shown, caused by input potential, if present. This current may flow through the external feedback resistor and result in an apparent output signal. In most shutdown applications the presence of this output is inconsequential. However, if the output is "forced" by another device, the other device will need to conduct the current described in order to maintain the output potential.

To keep the output at or near ground during shutdown when there is no other device to hold the output low, a switch using a transistor can be used to shunt the output to ground.

SELECTION OF R_F AND EFFECT ON STABILITY AND PEAKING

The peaking of the LMH6611 depends on the value of the R_F . From the graph shown in *Figure 3*, as the R_F value increases, the peaking increases.

For $A_V = 2$, at $R_F = 1 \text{ k}\Omega$, the -3 dB bandwidth is 113 MHz and peaking is about 0.6 dB whereas at $R_F = 665\Omega$, the -3 dB bandwidth is about 110 MHz and peaking is 0 dB. R_F and the input capacitance form a pole in the amplifier's response. If the time constant is too big, it will cause peaking and ringing. Except for $A_V = 1$ when R_F should be 0Ω , across all other gain settings it is recommended that R_F remain between 500Ω and $1 \text{ k}\Omega$ to ensure optimum performance.

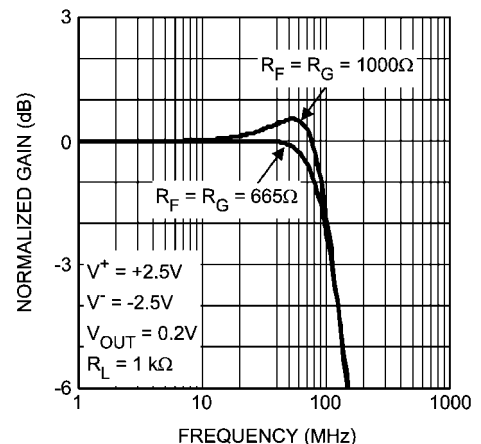

FIGURE 3. Closed Loop Gain vs. Frequency and $R_F = R_G$

$R_F = R_G$	f -3 dB (MHz)	Peaking (dB)
665	110	0
1000	113	0.6

MINIMIZING NOISE

With a low input voltage noise of $10 \text{ nV}/\sqrt{\text{Hz}}$ and an input current noise of $2 \text{ pA}/\sqrt{\text{Hz}}$ the LMH6611 and LMH6612 are suitable for high accuracy applications. Still being able to reduce the frequency band of operation of the various noise sources (i.e. op amp noise voltage, resistor thermal noise, input noise current) can further improve the noise performance of a system. In a non-inverting amplifier configuration inserting a capacitor, C_G , in series with the gain setting resistor, R_G , will reduce the gain of the circuit below frequency, $f = 1/2\pi R_G C_G$. This can be set to reduce the contribution of noise from the $1/f$ region. Alternatively applying a feedback capacitor, C_F , in parallel with the feedback resistor, R_F , will introduce a pole into your system at $f = 1/2\pi R_F C_F$ and create a low pass filter. This filter can be set to reduce high frequency noise and harmonics. Finally remember to keep resistor values as small as possible for a given application in order to reduce resistor thermal noise.

POWER SUPPLY BYPASS

Since the LMH6611 and LMH6612 are wide bandwidth amplifiers, proper power supply bypassing is critical for optimum performance. Improper power supply bypassing can result in large overshoot, ringing or oscillation. $0.1 \mu\text{F}$ capacitors should be connected from the supply pins, V^+ and V^- , to ground, as close to the device as is practical. Additionally, a $10 \mu\text{F}$ electrolytic capacitor should be connected from both supply pins to ground reasonably close to the device. Finally, near the device a $0.1 \mu\text{F}$ ceramic capacitor between the supplies will provide the best harmonic distortion performance.

INTERFACING HIGH PERFORMANCE OP AMPS WITH ADCs

These amplifiers are designed for ease of use in a wide range of applications requiring high speed, low supply current, low noise, and the ability to drive complex ADC and video loads.

The source that drives the modern high resolution analog-to-digital converters (ADCs) sees a high frequency AC load and a DC load of a few hundred ohms or more. Thus, a high performance op amp with high input impedance of a few mega ohms and low output impedance would be an ideal choice as an input ADC driver. The LMH6611/LMH6612 have the low output impedance of 0.07Ω at $f = 1 \text{ MHz}$. The ADC driver acts as a buffer and a low pass filter to reduce the overall system noise. To utilize the full dynamic range of the ADC, the ADC input has to be driven to full scale input voltage.

As signals travel through the traces of a printed circuit board (PCB) and long cables, system noise accumulates in the signals and a differential ADC rejects any signals noise that appears as a common mode voltage. There are a couple of advantages to using differential signals rather than single-ended signals. First, differential signals double the dynamic range of the ADC and second, they offer better harmonic distortion performance. There are several ways to produce differential signals from a dual op amp configuration. One method is to utilize the single-ended to differential conversion technique and the other is the differential to differential conversion technique. The first method requires a single input source and the second method requires differential input source.

A real world input source can have non-ideal impedance thus the buffer amplifier, with very low output impedance, is re-

quired to drive the input of the ADC. To minimize the droop in the input voltage, external shunt capacitance (C_L) should be about ten times larger than the internal input capacitance of the ADC and external series resistance (R_L) should be large enough to maintain the phase delay at the output of the op amp and hence maintain the stability (See Figure 4). Most applications benefit from the inclusion of a series isolation resistor connected between the op amp output and ADC input. This series resistor helps to limit the output current of the op amp. The value chosen for this series resistor is very important, as a higher value will increase the load impedance seen by the op amp and improve the total harmonic distortion (THD) performance of the op amp; however, the ADC prefers a low impedance source driving it. Thus, the optimum value for this series resistor must be found so that it will offer the best performance in terms of THD, SNR and SFDR of the combined op amp and ADC.

Important Specifications of Op Amp and ADC

When interfacing an ADC with an op amp it is imperative to understand the specifications that are important to get the expected performance results. Modern ADC AC specifications such as THD, SNR, settling time and SFDR are critical for filtering, test and measurement, video and reconstruction applications. The high performance op amp's settling time, THD, and noise performance must be better than that of the ADC it is driving to maintain the proper system accuracy with minimal or no error.

Some system applications require low THD, low SFDR and wide dynamic range (SNR), whereas some system applications require high SNR and they may sacrifice THD and SFDR to focus on the noise performance.

Noise is a very important specification for both the op amp and the ADC. There are three main sources of noise that contribute to the overall performance of the ADC: Quantization noise, noise generated by the ADC itself (particularly at higher frequencies) and the noise generated by the application circuit. The impedance of the input source affects the noise performance of the op amp. Theoretically, an ADC's signal to noise ratio (SNR) can be found from the equation:

$$\text{SNR (in dB)} = 6.02 * N + 1.72$$

where N is the resolution of the ADC. For example, according to this equation a 12-bit ADC has an SNR of 74 dB. However, the practical SNR number would be about 72 dB. In order to achieve better SNR, the ADC driver noise should be as small as possible. The LMH6611/LMH6612 have the low voltage noise of only $10 \text{ nV}/\sqrt{\text{Hz}}$.

The combined settling time of the op amp and the ADC must be within 1 LSB. The 0.01% settling time of the LMH6611/LMH6612 is 100 ns.

The ADC driver's THD should be inherently lower than that of the ADC. The LMH6611/LMH6612 have an SFDR of 96 dBc at $2 V_{PP}$ output and 1 MHz input frequency.

Signal to Noise and Distortion (SINAD) is a parameter which is the combination of the SNR and THD specifications. SINAD is defined as the RMS value of the output signal to the RMS value of all of the other spectral components below half the clock frequency, including harmonics but excluding DC. It can be calculated from SNR and THD according to the equation:

$$\text{SINAD} = 20 * \text{LOG} \sqrt{10^{-\frac{\text{SNR}}{10}} + 10^{-\frac{\text{THD}}{10}}}$$

Because SINAD compares all undesired frequency components with the input frequency, it is an overall measure of an ADC's dynamic performance. The following sections will discuss the three different ADC driver architectures in detail.

SINGLE TO SINGLE ADC DRIVER

This architecture has a single-ended input source connected to the input of the op amp and the single-ended output of the op amp is then fed to the single-ended input of the ADC. The low noise of only 10 nV/√Hz and a wide bandwidth of 345 MHz make the LMH6611 an excellent choice for driving the 12-bit ADC121S101 500 KSPS to 1 MSPS ADC, which has a successive approximation architecture with internal sample and hold circuits. Figure 2 shows the schematic of the LMH6611 in a 2nd order multiple-feedback with gain of -1 (inverting) configuration, driving an ADC121S101. The inverting configuration

is preferred over the non-inverting configuration, as it offers more linear output response. Table 1 shows the performance data of the LMH6611 combined with the ADC121S101. The ADC driver's cutoff frequency of 500 kHz is found from the equation:

$$f_0 = \frac{1}{2\pi} \times \sqrt{\frac{1}{R_2 \times R_5 \times C_2 \times C_5}}$$

The op amp's gain is set by the equation:

$$\text{GAIN} = - \frac{R_2}{R_1}$$

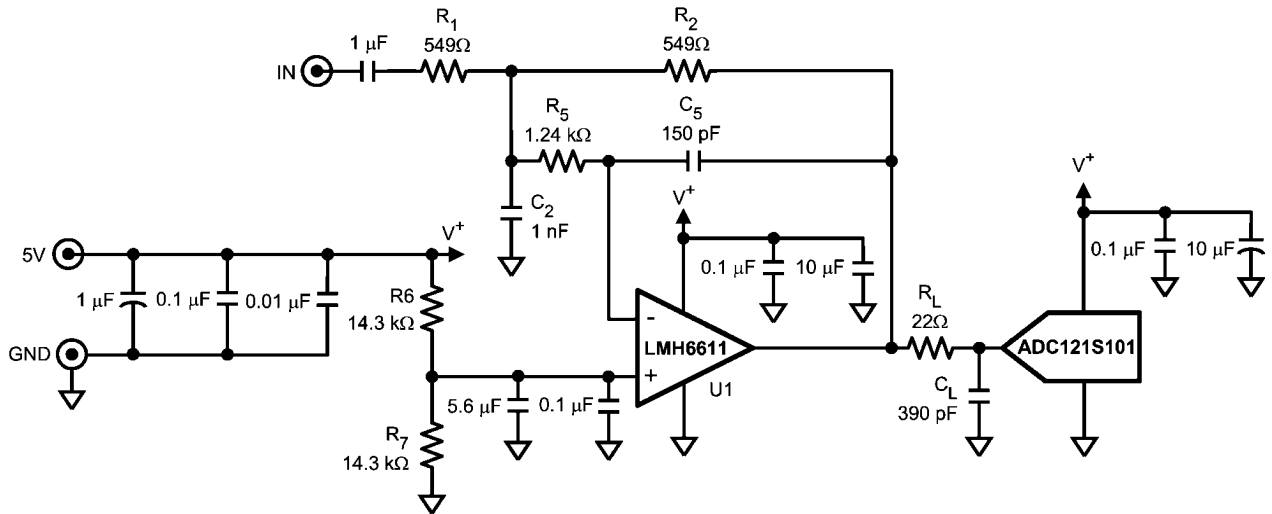

30033629

FIGURE 4. Single to Single ADC Driver

TABLE 1. Performance of the LMH6611 Combined with the ADC121S101

Amplifier Output/ADC Input	SINAD	SNR	THD	SFDR	ENOB	Notes
	(dB)	(dB)	(dB)	(dBc)		
4	70.2	71.6	-75.7	77.6	11.4	ADC121S101 @ f = 200 kHz

When the op amp and the ADC are using the same supply, it is important that both devices are well bypassed. A 0.1 μF ceramic capacitor and a 10 μF tantalum capacitor should be located as close as possible to each supply pin. A sample layout is shown in Figure 5. The 0.1 μF capacitors (C13 and C6) and the 10 μF capacitors (C11 and C5) are located very close to the supply pins of the LMH6611 and the ADC121S101.

The following are recommendations for the design of PCB layout in order to obtain the optimum high frequency performance:

- Place ADC and amplifier as close together as possible.
- Put the supply bypassing capacitors as close as possible to the device (<1").
- Utilize surface mount instead of through-hole components and ground and power planes.
- Keep the traces short where possible.
- Use terminated transmission lines for long traces.

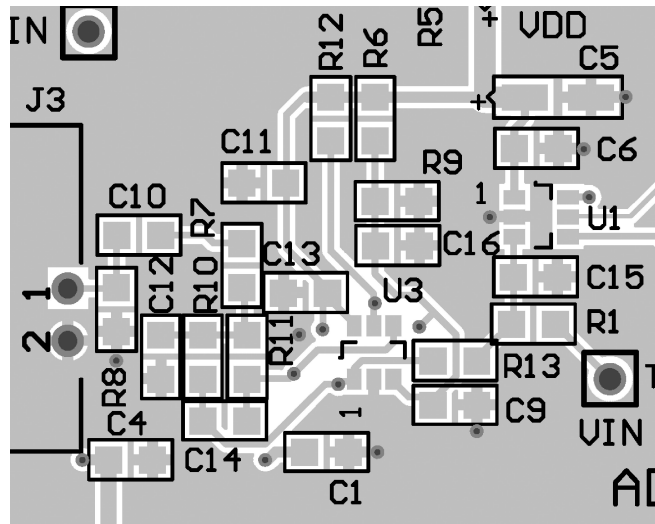

30033640

FIGURE 5. LMH6611 and ADC121S101 Layout

SINGLE-ENDED TO DIFFERENTIAL ADC DRIVER

The single-ended to differential ADC driver in Figure 3 utilizes an LMH6612 dual op amp to buffer a single-ended source to drive an ADC with differential inputs. One of the op amps is configured as a unity gain buffer that drives the inverting (IN-) input of the op amp U2 and non-inverting (IN+) input of the ADC121S625. U2 inverts the input signal and drives the inverting input of the ADC121S625. The ADC driver is configured for a gain of +2 to reduce the noise without sacrificing THD performance. The common mode voltage of 2.5V is set

up at the non-inverting inputs of both op amps U1 and U2. This configuration produces differential $\pm 2.5 V_{PP}$ output signals, when the single-ended input signal of 0 to V_{REF} is AC coupled into the non-inverting terminal of the op amp and each non-inverting terminal of the op amp is biased at the mid-scale of 2.5V. The two output RC anti-aliasing filters are used between both the outputs of U1 and U2 and the input of the ADC121S625 to minimize the effect of undesired high frequency noise coming from the input source. Each RC filter has the cutoff frequency of approximately 22 MHz.

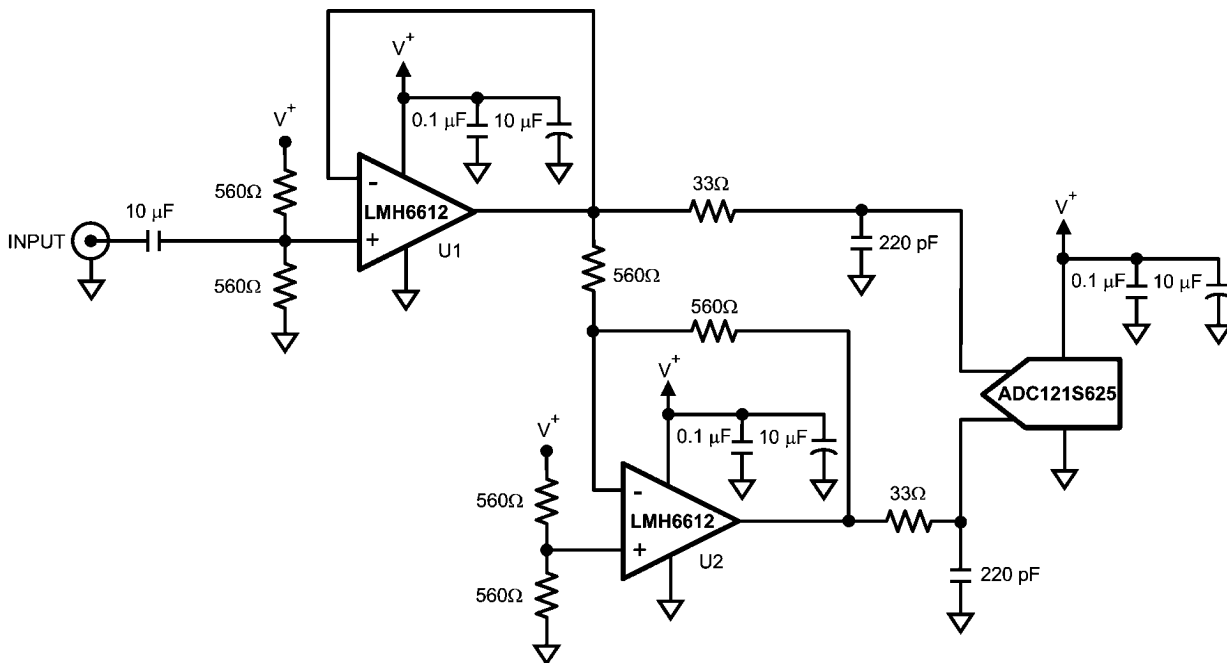

30033680

FIGURE 6. Single-Ended to Differential ADC Driver

The performance of the LMH6612 with the ADC121S625 is shown in Table 2.

TABLE 2. Performance of the LMH6612 Combined with the ADC121S625

Amplifier Output/ADC Input	SINAD	SNR	THD	SFDR	ENOB	Notes
	(dB)	(dB)	(dB)	(dBc)		
2.5	68.8	69	-81.5	75.1	11.2	ADC121S625 @ f = 20 kHz

DIFFERENTIAL TO DIFFERENTIAL ADC DRIVER

The LMH6612 dual op amp can be configured as a differential to differential ADC driver to buffer a differential source to a differential input ADC as shown in Figure 7. The differential to differential ADC driver can be formed using two single to

single ADC drivers. Each output from these drivers goes to a separate input of the differential ADC. Here, each single to single ADC driver uses the same components and is configured for a gain of -1 (inverting).

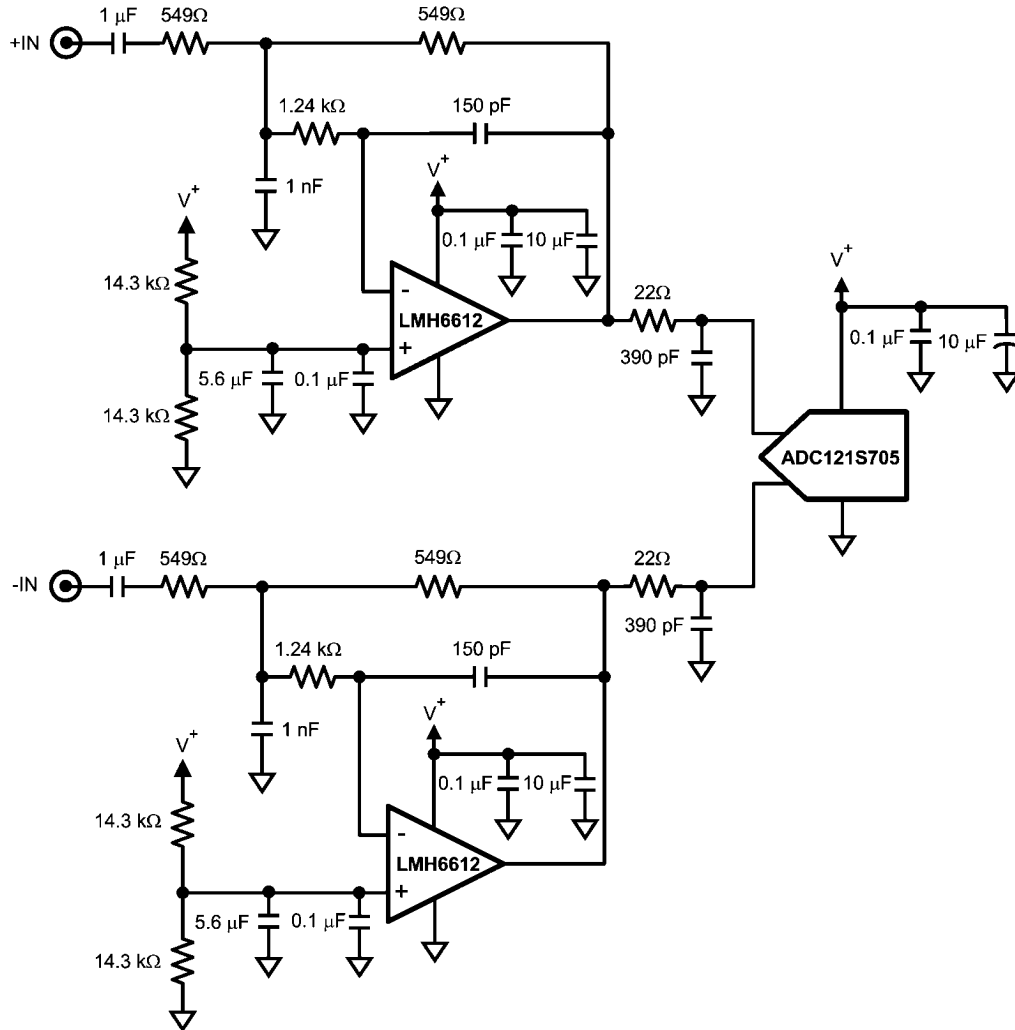

30033642

FIGURE 7. Differential to Differential ADC Driver

The following table summarizes the performance of the LMH6612 combined with the ADC121S625 at two different frequencies. In order to utilize the full dynamic range of the

ADC, the maximum input of 2.5 V_{PP} is applied to the ADC input. *Figure 8* shows the FFT plot of the LMH6612 and ADC121S625 combination tested at f = 20 kHz input frequency.

TABLE 3. Performance of the LMH6612 Combined with the ADC121S625

Amplifier Output/ADC Input	SINAD	SNR	THD	SFDR	ENOB	Notes
	(dB)	(dB)	(dB)	(dBc)		
2.5	72.2	72.3	-87.7	92.1	11.7	ADC121S625 @ f = 20 kHz
2.5	72.2	72.2	-87.8	90.8	11.7	ADC121S625 @ f = 200 kHz

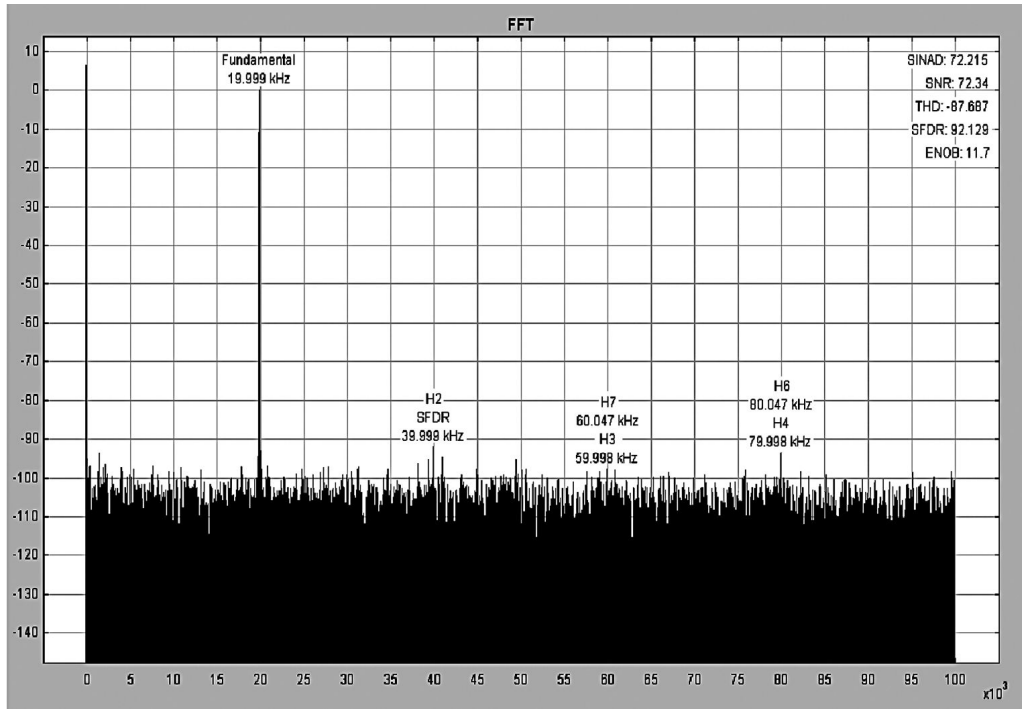

30033673

FIGURE 8. The FFT Plot of Differential to Differential ADC Driver

DC LEVEL SHIFTING

Often a signal must be both amplified and level shifted while using a single supply for the op amp. The circuit in *Figure 9* can do both of these tasks. The procedure for specifying the resistor values is as follows.

1. Determine the input voltage.
2. Calculate the input voltage midpoint, $V_{INMID} = V_{INMIN} + (V_{INMAX} - V_{INMIN})/2$.
3. Determine the output voltage needed.
4. Calculate the output voltage midpoint, $V_{OUTMID} = V_{OUTMIN} + (V_{OUTMAX} - V_{OUTMIN})/2$.
5. Calculate the gain needed, $gain = (V_{OUTMAX} - V_{OUTMIN}) / (V_{INMAX} - V_{INMIN})$.
6. Calculate the amount the voltage needs to be shifted from input to output, $\Delta V_{OUT} = V_{OUTMID} - gain \times V_{INMID}$.
7. Set the supply voltage to be used.
8. Calculate the noise gain, $noise\ gain = gain + \Delta V_{OUT}/V_S$.
9. Set R_F .
10. Calculate R_1 , $R_1 = R_F/gain$.
11. Calculate R_2 , $R_2 = R_F/(noise\ gain - gain)$.
12. Calculate R_G , $R_G = R_F/(noise\ gain - 1)$.

Check that both the V_{IN} and V_{OUT} are within the voltage ranges of the LMH6611.

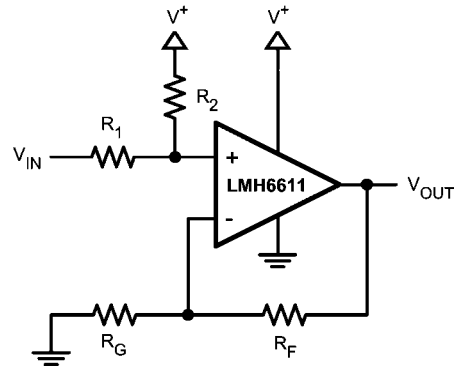

30033648

FIGURE 9. DC Level Shifting

The following example is for a V_{IN} of 0V to 1V with a V_{OUT} of 2V to 4V.

1. $V_{IN} = 0V$ to $1V$
2. $V_{INMID} = 0V + (1V - 0V)/2 = 0.5V$
3. $V_{OUT} = 2V$ to $4V$
4. $V_{OUTMID} = 2V + (4V - 2V)/2 = 3V$
5. $Gain = (4V - 2V)/(1V - 0V) = 2$
6. $\Delta V_{OUT} = 3V - 2 \times 0.5V = 2$
7. For the example the supply voltage will be +5V.
8. $Noise\ gain = 2 + 2/5V = 2.4$
9. $R_F = 2\ k\Omega$
10. $R_1 = 2\ k\Omega/2 = 1\ k\Omega$
11. $R_2 = 2\ k\Omega/(2.4 - 2) = 5\ k\Omega$
12. $R_G = 2\ k\Omega/(2.4 - 1) = 1.43\ k\Omega$

4th ORDER MULTIPLE FEEDBACK LOW-PASS FILTER

Figure 10 shows the LMH6612 used as the amplifier in a multiple feedback low pass filter. This filter is set up to have a gain

of +1 and a -3 dB point of 1 MHz. Values can be determined by using the WEBENCH® Active Filter Designer found at www.amplifiers.national.com.

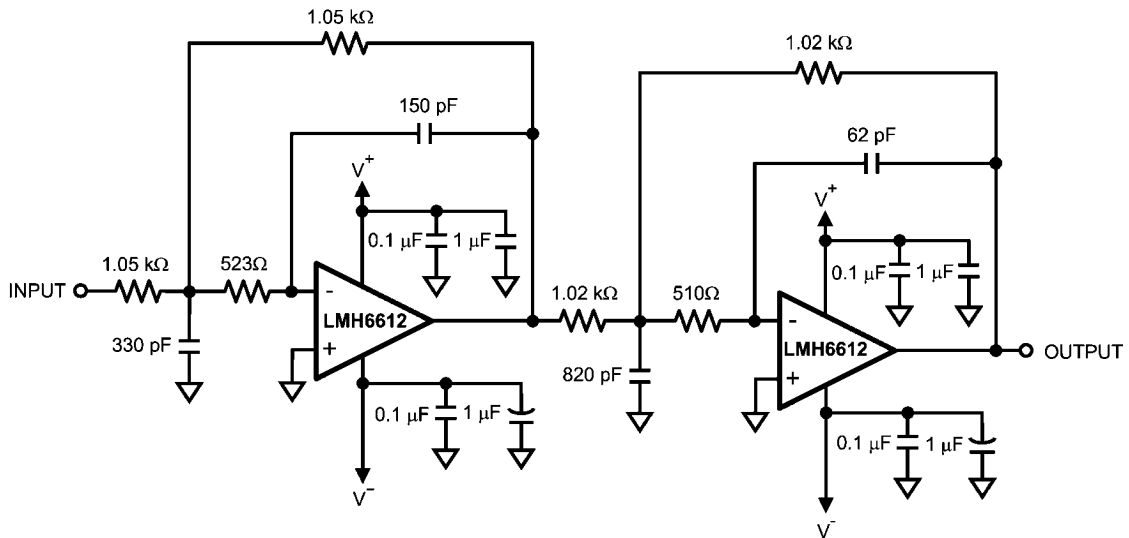

30033628

FIGURE 10. 4th Order Multiple Feedback Low-Pass Filter

CURRENT SENSE AMPLIFIER AND OPTIMIZING ACCURACY IN PRECISION APPLICATIONS

With its rail-to-rail output capability, low V_{OS} , and low I_B the LMH6611 is an ideal choice for a current sense amplifier application. Figure 11 shows the schematic of the LMH6611 set up in a low-side sense configuration which provides a conversion gain of 2V/A. Voltage error due to V_{OS} can be calculated to be $V_{OS} \times (1 + R_F/R_G)$ or $0.6 \text{ mV} \times 21 = 12.6 \text{ mV}$. Voltage error due to I_O is $I_O \times R_F$ or $0.5 \mu\text{A} \times 1 \text{ k}\Omega = 0.5 \text{ mV}$. Hence worst case total voltage error is $12.6 \text{ mV} + 0.5 \text{ mV}$ or 13.1 mV which translates into a current error of $13.1 \text{ mV}/(2 \text{ V/A}) = 6.55 \text{ mA}$.

This circuit employs DC source resistance matching at the two input terminals in order to minimize the output DC error caused by input bias current. Another technique to reduce output offset in a non-inverting amplifier configuration is to introduce a DC offset current into the inverting input of the amplifier. To ensure minimal impact on frequency response be sure to inject the DC offset current through large resistors. Conversely if optimizing an inverting amplifier configuration simply apply offset adjustment to the non-inverting input.

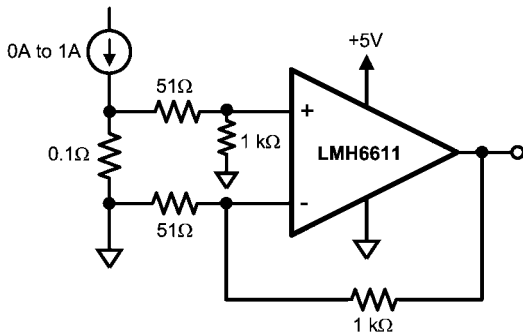

30033641

FIGURE 11. Current Sense Amplifier

TRANSIMPEDANCE AMPLIFIER

By definition, a photodiode produces either a current or voltage output from exposure to a light source. A Transimpedance Amplifier (TIA) is utilized to convert this low-level current to a usable voltage signal. The TIA often will need to be compensated to insure proper operation.

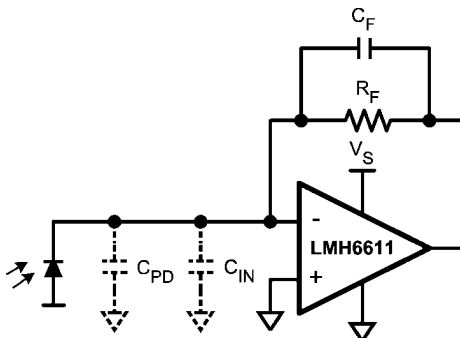

30033662

FIGURE 12. Photodiode Modeled with Capacitance Elements

Figure 12 shows the LMH6611 modeled with photodiode and the internal op amp capacitances. The LMH6611 allows circuit operation of a low intensity light due to its low input bias

current by using larger values of gain (R_F). The total capacitance (C_T) on the inverting terminal of the op amp includes the photodiode capacitance (C_{PD}) and the input capacitance of the op amp (C_{IN}). This total capacitance (C_T) plays an important role in the stability of the circuit. The noise gain of this circuit determines the stability and is defined by:

$$NG = \frac{1 + sR_F(C_T + C_F)}{1 + sC_F R_F} \tag{1}$$

$$\text{Where, } f_z \cong \frac{1}{2\pi R_F C_T} \text{ and } f_p = \frac{1}{2\pi R_F C_F} \tag{2}$$

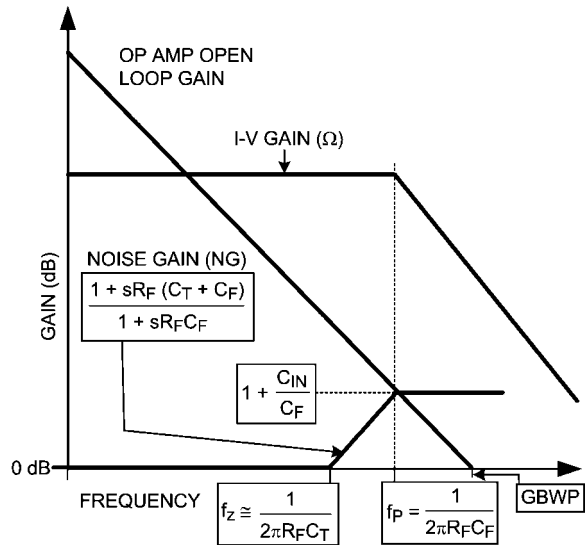

30033665

FIGURE 13. Bode Plot of Noise Gain Intersecting with Op Amp Open Loop Gain

Figure 13 shows the bode plot of the noise gain intersecting the op amp open loop gain. With larger values of gain, C_T and R_F create a zero in the transfer function. At higher frequencies the circuit can become unstable due to excess phase shift around the loop.

A pole at f_p in the noise gain function is created by placing a feedback capacitor (C_F) across R_F . The noise gain slope is flattened by choosing an appropriate value of C_F for optimum performance.

Theoretical expressions for calculating the optimum value of C_F and the expected -3 dB bandwidth are:

$$C_F = \sqrt{\frac{C_T}{2\pi R_F (GBWP)}} \tag{3}$$

$$f_{-3 \text{ dB}} = \sqrt{\frac{GBWP}{2\pi R_F C_T}} \tag{4}$$

Equation 4 indicates that the -3 dB bandwidth of the TIA is inversely proportional to the feedback resistor. Therefore, if the bandwidth is important then the best approach would be to have a moderate transimpedance gain stage followed by a broadband voltage gain stage.

Table 4 shows the measurement results of the LMH6611 with different photodiodes having various capacitances (C_{PD}) and a feedback resistance (R_F) of $1 \text{ k}\Omega$.

TABLE 4. TIA (Figure 1) Compensation and Performance Results

C_{PD} (pF)	C_T (pF)	C_F CAL (pF)	C_F USED (pF)	$f_{-3\text{ dB CAL}}$ (MHz)	$f_{-3\text{ dB MEAS}}$ (MHz)	Peaking (dB)
22	24	5.42	5.6	29.3	27.1	0.5
47	49	7.75	8	20.5	21	0.5
100	102	11.15	12	14.2	15.2	0.5
222	224	20.39	18	9.6	10.7	0.5
330	332	20.2	22	7.9	9	0.8

Note:
 GBWP = 130 MHz
 $C_T = C_{PD} + C_{IN}$
 $C_{IN} = 2\text{ pF}$
 $V_S = \pm 2.5\text{ V}$

Figure 14 shows the frequency response for the various photodiodes in Table 4.

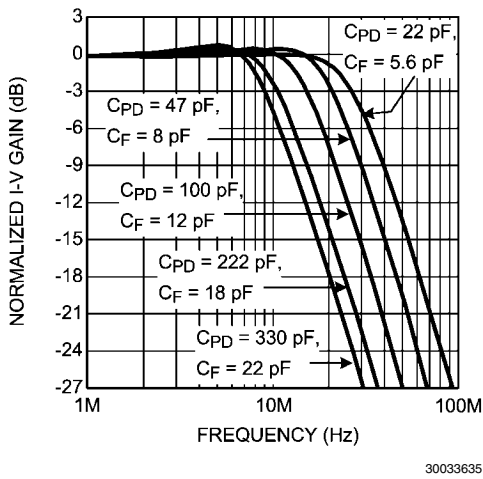

FIGURE 14. Frequency Response for Various Photodiode and Feedback Capacitors

When analyzing the noise at the output of the TIA, it is important to note that the various noise sources (i.e. op amp

noise voltage, feedback resistor thermal noise, input noise current, photodiode noise current) do not all operate over the same frequency band. Therefore, when the noise at the output is calculated, this should be taken into account. The op amp noise voltage will be gained up in the region between the noise gain's zero and pole (f_z and f_p in Figure 13). The higher the values of R_F and C_T , the sooner the noise gain peaking starts and therefore its contribution to the total output noise will be larger. It is advantageous to minimize C_{IN} by proper choice of op amp or by applying a reverse bias across the diode but this will be at the expense of excess dark current and noise.

EVALUATION BOARD

National Semiconductor provides the following evaluation board as a guide for high frequency layout and as an aid in device testing and characterization. Many of the datasheet plots were measured with this board:

Device	Package	Board Part #
LMH6611MK	TSOT23	LMH730216

This evaluation board can be shipped when a device sample request is placed with National Semiconductor.

Physical Dimensions inches (millimeters) unless otherwise noted

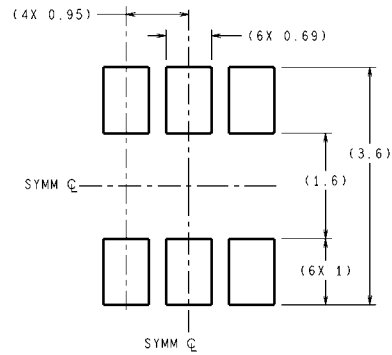
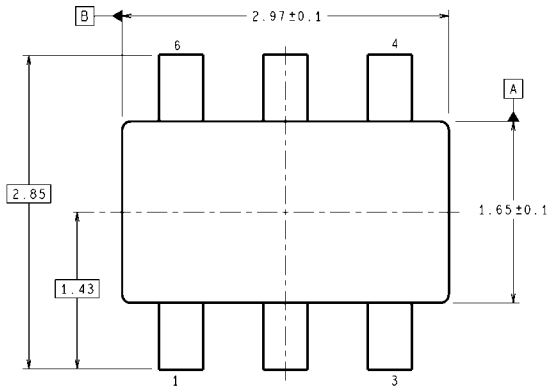

RECOMMENDED LAND PATTERN

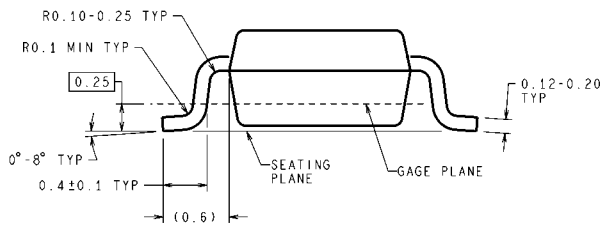
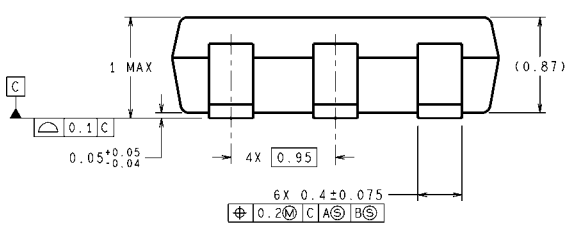

DIMENSIONS ARE IN MILLIMETERS

MK06A (Rev D)

**6-Pin TSOT23
NS Package Number MK06A**

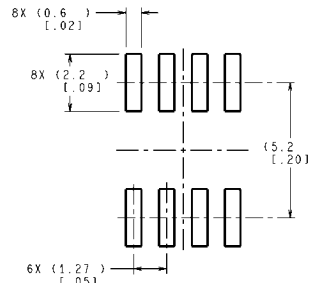
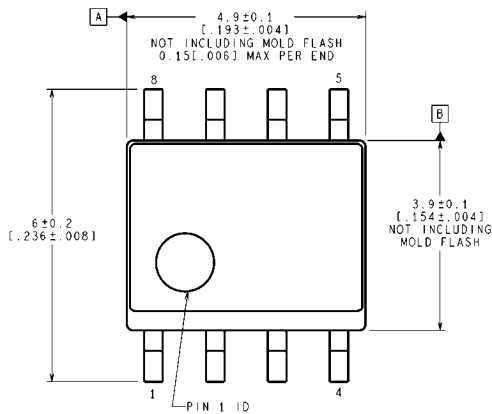

RECOMMENDED LAND PATTERN

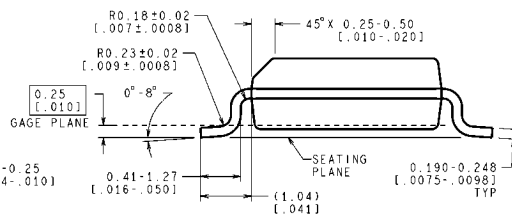
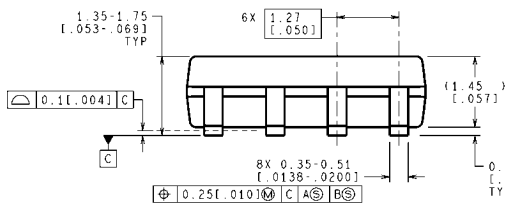

CONTROLLING DIMENSION IS MILLIMETER
VALUES IN [] ARE INCHES
DIMENSIONS IN () FOR REFERENCE ONLY

M08A (Rev L)

**8-Pin SOIC
NS Package Number M08A**

For more National Semiconductor product information and proven design tools, visit the following Web sites at:

Products		Design Support	
Amplifiers	www.national.com/amplifiers	WEBENCH	www.national.com/webench
Audio	www.national.com/audio	Analog University	www.national.com/AU
Clock Conditioners	www.national.com/timing	App Notes	www.national.com/appnotes
Data Converters	www.national.com/adc	Distributors	www.national.com/contacts
Displays	www.national.com/displays	Green Compliance	www.national.com/quality/green
Ethernet	www.national.com/ethernet	Packaging	www.national.com/packaging
Interface	www.national.com/interface	Quality and Reliability	www.national.com/quality
LVDS	www.national.com/lvds	Reference Designs	www.national.com/refdesigns
Power Management	www.national.com/power	Feedback	www.national.com/feedback
Switching Regulators	www.national.com/switchers		
LDOs	www.national.com/ldo		
LED Lighting	www.national.com/led		
PowerWise	www.national.com/powerwise		
Serial Digital Interface (SDI)	www.national.com/sdi		
Temperature Sensors	www.national.com/tempsensors		
Wireless (PLL/VCO)	www.national.com/wireless		

THE CONTENTS OF THIS DOCUMENT ARE PROVIDED IN CONNECTION WITH NATIONAL SEMICONDUCTOR CORPORATION ("NATIONAL") PRODUCTS. NATIONAL MAKES NO REPRESENTATIONS OR WARRANTIES WITH RESPECT TO THE ACCURACY OR COMPLETENESS OF THE CONTENTS OF THIS PUBLICATION AND RESERVES THE RIGHT TO MAKE CHANGES TO SPECIFICATIONS AND PRODUCT DESCRIPTIONS AT ANY TIME WITHOUT NOTICE. NO LICENSE, WHETHER EXPRESS, IMPLIED, ARISING BY ESTOPPEL OR OTHERWISE, TO ANY INTELLECTUAL PROPERTY RIGHTS IS GRANTED BY THIS DOCUMENT.

TESTING AND OTHER QUALITY CONTROLS ARE USED TO THE EXTENT NATIONAL DEEMS NECESSARY TO SUPPORT NATIONAL'S PRODUCT WARRANTY. EXCEPT WHERE MANDATED BY GOVERNMENT REQUIREMENTS, TESTING OF ALL PARAMETERS OF EACH PRODUCT IS NOT NECESSARILY PERFORMED. NATIONAL ASSUMES NO LIABILITY FOR APPLICATIONS ASSISTANCE OR BUYER PRODUCT DESIGN. BUYERS ARE RESPONSIBLE FOR THEIR PRODUCTS AND APPLICATIONS USING NATIONAL COMPONENTS. PRIOR TO USING OR DISTRIBUTING ANY PRODUCTS THAT INCLUDE NATIONAL COMPONENTS, BUYERS SHOULD PROVIDE ADEQUATE DESIGN, TESTING AND OPERATING SAFEGUARDS.

EXCEPT AS PROVIDED IN NATIONAL'S TERMS AND CONDITIONS OF SALE FOR SUCH PRODUCTS, NATIONAL ASSUMES NO LIABILITY WHATSOEVER, AND NATIONAL DISCLAIMS ANY EXPRESS OR IMPLIED WARRANTY RELATING TO THE SALE AND/OR USE OF NATIONAL PRODUCTS INCLUDING LIABILITY OR WARRANTIES RELATING TO FITNESS FOR A PARTICULAR PURPOSE, MERCHANTABILITY, OR INFRINGEMENT OF ANY PATENT, COPYRIGHT OR OTHER INTELLECTUAL PROPERTY RIGHT.

LIFE SUPPORT POLICY

NATIONAL'S PRODUCTS ARE NOT AUTHORIZED FOR USE AS CRITICAL COMPONENTS IN LIFE SUPPORT DEVICES OR SYSTEMS WITHOUT THE EXPRESS PRIOR WRITTEN APPROVAL OF THE CHIEF EXECUTIVE OFFICER AND GENERAL COUNSEL OF NATIONAL SEMICONDUCTOR CORPORATION. As used herein:

Life support devices or systems are devices which (a) are intended for surgical implant into the body, or (b) support or sustain life and whose failure to perform when properly used in accordance with instructions for use provided in the labeling can be reasonably expected to result in a significant injury to the user. A critical component is any component in a life support device or system whose failure to perform can be reasonably expected to cause the failure of the life support device or system or to affect its safety or effectiveness.

National Semiconductor and the National Semiconductor logo are registered trademarks of National Semiconductor Corporation. All other brand or product names may be trademarks or registered trademarks of their respective holders.

Copyright© 2008 National Semiconductor Corporation
 For the most current product information visit us at www.national.com

 <p>National Semiconductor Americas Technical Support Center Email: support@nsc.com Tel: 1-800-272-9959</p>	<p>National Semiconductor Europe Technical Support Center Email: europe.support@nsc.com German Tel: +49 (0) 180 5010 771 English Tel: +44 (0) 870 850 4288</p>	<p>National Semiconductor Asia Pacific Technical Support Center Email: ap.support@nsc.com</p>	<p>National Semiconductor Japan Technical Support Center Email: jpn.feedback@nsc.com</p>
--	--	---	--